

# **Compact ICS 6.0 Installer Guide**

Norstar and Meridian are trademarks of Nortel Networks  
© Copyright Nortel Networks 2002

1-800-4 NORTEL  
[www.nortel.com/norstar](http://www.nortel.com/norstar)

P0992669 03  
Printed in Canada



# Table of Contents

---

## Regulations 13

- Installation Safety warning 13
  - North American Regulations  
(Canada and United States) 14
  - International regulatory 18
- 

## What's new with Norstar 19

- New features for version 6.0 19
  - Functionality changes for version 6.0 20
- 

## Welcome to ISDN 21

- Comparing ISDN to Analog 21
  - BRI ISDN service 22
  - ISDN layers 23
  - ISDN Bearer capability 23
  - Services and features for ISDN BRI 24
  - ISDN hardware 26
  - Clock Source for ISDN Cards 29
  - Other ISDN BRI equipment 30
  - ISDN standards compatibility 31
  - Planning your ISDN network 31
  - Ordering ISDN BRI 31
  - ISDN programming 33
  - Programming ISDN equipment 36
- 

## Networking with Norstar 41

- The big picture 41
  - Norstar behind a PBX 41
  - Trunks and target lines 42
    - Loop start trunks 42
    - BRI trunks 44
    - Target lines 44
  - Remote system access 45
    - Remote access on loop start trunks 45
  - Networking features 46
    - Security 46
-

## **Data Solutions 53**

- Examples of ISDN Scenarios 53
  - ISDN applications 53
  - Video conferencing and video telephony 53
  - Desktop conferencing 53
  - File transfer 53
  - Telecommuting 54
  - Group 4 fax 54
  - Remote LAN access 54
  - Leased line backup 54
  - LAN to LAN bridging 54
  - Internet and database access 54
- 

## **Planning the installation 55**

- Planning checklist 55
  - Equipment and supplies 55
  - Optional equipment 56
  - Equipment for installing the ICS 56
  - Location requirements 57
  - Electrical requirements 57
  - Internal wiring requirements 58
  - Spacing requirements 59
- 

## **Upgrading your system 61**

- Upgrading a restricted Feature Cartridge 62
  - Upgrading from 16 telephones to 24 telephones 62
  - Upgrading to Compact ICS 6.0 63
  - Upgrading Expansion Cartridge for BRI Card installation 65
- 

## **Installation 67**

- Installation checklist 68
  - Testing the ISDN network connection 70
  - Mounting the ICS 71
  - Installing the cartridges 72
    - Removing the cover 74
    - Installing the Feature Cartridge 75
    - Terminating resistors on BRI-ST Cards 76
    - Installing Trunk Cartridges 78
-

- 
- Installing the Expansion Cartridge 81
  - Connecting the wiring 83
    - Connecting the wiring to the distribution panel 84
    - Wiring charts 84
    - BRI Wiring charts 92
  - Installing Norstar telephones 98
    - Installing the emergency telephone 98
    - Installing the device that uses the I-ATA 99
    - Installing Business Series Terminals 100
    - Installing Norstar telephones 102
  - Installing ISDN terminal equipment 105
    - S or T wiring for terminal equipment 105
    - S or T extension wiring configurations 105
    - U-LT wiring for terminal equipment 106
  - Installing optional equipment 108
    - Auxiliary ringer (customer supplied) 108
    - External music source (customer supplied) 108
    - External paging system (customer supplied) 109
  - Powering up the system 111
- 

## **Programming 113**

- Programming overview 113
- Profile, Dialpad and Startup programming 114
- Admin/Basic programming 116
- Programming tools 117
- Exiting programming 121
- Viewing your programming updates 121
- Entering numbers 122
  - Copying telephone programming 122
- Profiles and Dialpads 126
  - Profile programming 126
  - Dialpad programming 129
- Startup programming 130
  - Performing Startup 130
- Programming 133
  - Entering programming for installers 134
  - Entering programming for system coordinators 134
  - Entering programming using other passwords 135
  - Programming sequence 135
- Terminals&Sets 136

- Line access 136
- Line assignment 137
- Line pool access 138
- Prime line 139
- Intercom keys 140
- Answer DN's 140
- OLI # 141
- Capabilities 142
- ATA settings 144
- Name 145
- User preferences 145
- Restrictions 146
- Telco features 151
- Caller ID set 152
- Lines 155
  - Trunk/Line data 155
  - Copying Trunk and Line data 156
  - Trunk type 156
  - Line type 157
  - Dial mode 158
  - Prime set 158
  - Auto privacy 159
  - Trunk mode 159
  - Ans mode 160
  - Ans with DISA 160
  - Aux. ringer 160
  - Full AutoHold 161
  - LossPkg 162
  - Rec'd # 163
  - Name 164
  - Restrictions 164
  - Restr'n filters 164
  - Line restrns 165
  - Remote restrns 166
  - Telco features 167
- Services 168
  - Ringin' service 168
  - Restr'n service 172
  - Routing service 172
  - Routes 174
  - Dest codes 174
  - Setting up a route for local calling 177

- 
- Setting up a route for long distance calling 178
  - Adding a long distance carrier access code 180
  - Programming for least cost routing 181
  - Night sched 182
  - Using dialing restrictions with routing 183
  - Common settings 184
  - Sys speed dial 187
  - Passwords 188
    - COS pswds 188
    - Call log pswds 190
    - Programming pswds 190
    - Installer 190
    - SysCoord+ 190
    - SysCoord 191
    - Basic 191
    - IRAD pswd 191
    - Hospitality password 192
  - Time&Date 193
  - System prgming 194
    - Hunt groups 194
    - Change DNs 200
    - Featr settings 201
    - DRT to prime 203
    - DRT delay 203
    - Host delay 207
    - Link time 207
    - Direct-Dial 211
    - CAP assignment 212
    - Access codes 213
    - Line pool codes 214
    - Park prefix 215
    - External code 215
    - Direct-dial # 216
    - Auto DN 217
    - DISA DN 217
    - Auto Attendant 218
    - Remote access 220
    - Rec'd # length 224
    - DN length 225
    - Network Name Display 227
    - Intrl modem 228

- Alarm reporting 229
- Release Reasons 232
- Hospitality Services 232
- ETSI: Network features (profile 2) 235
  - Malicious call identification (MCID) 235
  - Network Call Diversion 236
  - Selective Line Redirection 238
- Telco features 240
  - VMsg centr tel#s 240
  - Outgoing Name and Number Blocking 240
- Software Keys 242
  - SysID 242
  - Password Keys 242
- Hardware 243
  - Cd1-KSU 244
  - Discon timer 245
  - Loops 245
    - Loop 245
    - Type 246
  - Lines 246
  - No SPIDs assignd 246
  - # of B-channls 247
  - Network DNs 248
    - Call type 248
    - D-packet servc 249
    - D-packet servc 249
    - Lp201 249
    - TEIs 249
    - No TEIs on loop 249
  - Sampling 250
  - DNs on Loop 201 250
  - Assign DNs 250
  - Loop DN 251

---

## **I-RAD 253**

Connecting to the I-RAD 254



---

## Testing 255

---

### Troubleshooting 257

- Getting ready 258
- Types of problems 258
- General troubleshooting procedure 259
- Problems with telephones 260
  - Norstar telephone has faulty buttons, display, handset or other hardware problems 260
  - Norstar telephone display unreadable 260
  - Norstar telephone dead 261
  - Emergency telephone dead 262
- Problems with lines 263
  - Calls cannot be made (but can be received) 263
  - Dial tone absent on external lines 264
  - Hung lines at a telephone 264
  - Auto-answer line rings at a Norstar telephone 265
  - Prime telephone gets misdialed calls 266
  - Selected line shows 'Not in service' or 'Not available' 267
  - Selected line pool shows 'No free lines' 267
- Problems with the I-ATA 268
  - Calls do not ring and caller does not receive busy tone 268
  - I-ATA is always busy 268
  - Calls cannot be answered (or dial tone is not present when making calls) 269
  - Calls cannot be made (but dial tone is present) 269
- Problems with optional equipment 270
  - Auxiliary ringer 270
  - External paging 271
  - Music on Hold/Background Music trouble 271
- Problems with Trunk Cartridges 273
  - Trunk Cartridge trouble 273
- Problems with BRI service 274
  - The BRI card is connected to the ISDN network (U-loop) but the LED for one of more loops is not lit 274
  - "Out of service" is displayed when a BRI line is selected (LED for loop is lit) 275
  - All the LEDs on a BRI Card are flashing 275

- Caller hears one ring and then a fast busy signal when placing a call on a BRI line 276
  - Problems with the NT1 277
  - ICS down 278
  - Problems for network or remote users 280
    - Remote feature code gets no response 280
    - Dialed number gets ringback and the wrong person 280
    - Dialed number gets stuttered dial tone instead of ringback 281
    - Dialed number gets dial tone instead of ringback 281
    - Dialed number gets busy tone 282
    - Dialed number does not get through 282
    - Dialed DISA number gets ringback instead of stuttered dial tone 283
    - Dialed DISA number gets dial tone instead of stuttered dial tone 284
    - DISA user gets overflow tone when entering COS password 284
    - Dialed feature code gets overflow tone 286
    - Dialed feature code gets busy tone 287
    - Line pool access code gets overflow tone 287
    - Line pool access code gets ringback 288
    - Line pool access code gets busy tone 288
    - Dialed number gets no response 289
- 

## **Maintenance 291**

- Maintenance overview 291
  - Beginning a Maintenance session 292
  - System version 293
    - Checking the version of the system 293
  - Port/DN status 294
    - Identifying a device connected to the system 295
    - Checking the version number of the device 296
    - Checking the state of the device 297
    - Disabling a device 298
    - Enabling the device 299
    - Returning to the beginning 299
  - Module status 300
    - Looking at the module inventory 300
    - Checking the number of Trunk Cartridges attached to a module 300
    - Checking the state of a module 301
-

- 
- Checking the state of a cartridge 302
  - Disabling a module or its cartridges 302
  - Enabling a module or its cartridges 302
  - Returning to the beginning 303
  - System test log 304
    - Checking the items in the log 304
    - Checking the current alarm 304
    - Checking when each item in the log occurred 305
    - Checking the number of consecutive repetitions of an event or alarm 305
    - Erasing the log 305
  - System administration log 306
    - Checking the items in the log 306
    - Checking the current alarm 306
    - Checking when each item in the log occurred 307
    - Erasing the log 307
  - Provisioning 308
    - Cd1-KSU 308
  - Alarm codes 309
    - If you see an alarm code 309
    - Alarm troubleshooting 311
  - Event messages 314
    - Dealing with event messages 314
    - Significant event messages 314
  - Tests 320
    - Loopback test 320
    - Starting and stopping a payload loopback test 320
- 

## **Usage Metrics 323**

- Hunt groups 323
- 

## **Maintenance records 325**

- Recording information on the Maintenance records 325
- Version number record 325
- System test log record 327
- System administration log record 328

**Specifications 329**

---

**Glossary 333**

---

**SIndex 351**

Backup programming overlays 371

# Regulations

## Installation Safety warning



### ***Only qualified persons should service this system.***

The installation and service of this hardware is to be performed only by service personnel having appropriate training and experience necessary to be aware of hazards to which they are exposed in performing a task and of measures to minimize the danger to themselves or other persons.

Electrical shock hazards from the telecommunication network and AC mains are possible with this equipment. To minimize risk to service personnel and users, the system must be connected to an outlet with a third-wire ground.

Service personnel must be alert to the possibility of high leakage currents becoming available on metal system surfaces during power line fault events near network lines. These leakage currents normally safely flow to Protective Earth ground via the power cord.

Therefore, it is mandatory that connection to an earthed outlet is performed first and removed last when cabling the unit. Specifically, operations requiring the unit to be powered down must have the network connections (central office lines) removed first.

## North American Regulations (Canada and United States)

### Radio-frequency interference



#### ***Equipment generates RF energy.***

This equipment generates, uses, and can radiate radio-frequency energy. If not installed and used in accordance with the installation manual, it may cause interference to radio communications. It has been tested and found to comply with the limits for a Class A computing device pursuant to Part 15 of the FCC Rules and with Canadian Radio Interference Regulation SOR/88-475, which are designed to provide reasonable protection against such interference when used in a commercial environment. Operation of this equipment in a residential area is likely to cause interference, in which case the user, at his or her own expense, will be required to take whatever measures may be required to correct the interference.

### Telecommunication registration

Norstar equipment meets all applicable requirements of both Industry Canada CS-03 and US Federal Commission FCC Part 68 and has been registered under files Industry Canada 332-5980 A and FCC AB6CAN-20705-KF-E (key system), AB6CAN-20706-MF-E (hybrid system), and AB6CAN-23740-PF-E (PBX system). Connection of the Norstar key telephone system to the nationwide telecommunications network is made through a standard network interface jack that you can order from your local telecommunications company. This type of customer-provided equipment cannot be used on party lines or coin lines.

**NOTICE:** The Industry Canada label identifies certified equipment. This certification means that the equipment meets certain telecommunications network protective, operational and safety requirements. Industry Canada does not guarantee the equipment will operate to the user's satisfaction.

Before installing this equipment, users should ensure that it is permissible to be connected to the facilities of the local telecommunications company. The equipment must also be installed using an acceptable method of connection. It has been tested and found to comply with the limits for a Class A computing device pursuant to Part 15 of the FCC Rules and with ICES.003, Class A Canadian EMI requirements.

Repairs to certified equipment should be made by an authorized Canadian maintenance facility designated by the supplier. Any repairs or alterations made by the user to this equipment, or equipment malfunctions, may give the telecommunications company cause to request the user to disconnect the equipment. Users should ensure for their own protection that the electrical ground connections of the power utility, telephone lines and internal metallic water pipe system, if present, are connected together. This precaution may be particularly important in rural areas.

**CAUTION:** Users should not attempt to make such connections themselves, but should contact the appropriate electric inspection authority, or electrician, as appropriate.

## **Ringer Equivalence Number and Load Number**

The FCC and Industry Canada Registration information, on the front of the integrated communication system (ICS), includes the ringer equivalence number (REN) and load number (LN). These numbers show the electrical load that the Norstar ICS requires from a telephone line. If the ICS requires more electrical current than the telephone company's central office equipment can provide, telephones may not ring and you may have difficulty dialing telephone numbers.

In most areas, the total load on a line is allowed to be 5.0 REN or 100 LN. Call the local telecommunications company to find out the total REN or LN allowed for your telephone line.

## **Hearing-aid compatibility**

Norstar telephones are hearing-aid compatible, as defined in Section 68.316 of Part 68 FCC Rules.

## Electromagnetic compatibility

Norstar Compact ICS equipment meets all FCC Part 15, Class A radiated and conducted emissions requirements.

Norstar Compact ICS does not exceed the Class A limits for radiated and conducted emissions from digital apparatus as set out in the Radio Interference Regulations of Industry Canada.

## Safety

Norstar Compact ICS equipment meets all applicable requirements of both the Canadian Standards Association C22.2 No. 950-M1995 and US Underwriter's Laboratory UL Std. No. 1950 - 3rd Edition.

## Telephone company registration

It is usually not necessary to call the telecommunications company with information on the equipment before connecting the Norstar ICS to the telephone network. If the telecommunications company requires this information, provide the following:

- telephone number(s) to which the ICS will be connected
- FCC registration number (on label affixed to ICS)
- ringer equivalence number (REN)
- universal service order code (USOC)
- service order code (SOC)
- facility interface code (FIC)

Trunk Cartridge	REN	LN	USOC	SOC	FIC
GATC LSDS (NT7B69AAAA) replacing Loop Start/Disconnect Supervision (LS/DS)- NT7B75GA-93	AC 1.5B DC 0.3	8	RJ21X	9.0F	02LS2



<b>Trunk Cartridge</b>	<b>REN</b>	<b>LN</b>	<b>USOC</b>	<b>SOC</b>	<b>FIC</b>
GATC CI (NT7B75AAC) replacing Call Information (CI)- NT5B41GA-93	AC 1.5B DC 0.3	8	RJ21X	9.0F	02LS2
BRI-U2 and BRI-U4 Cards NT7B86GB-93 and NT7B87GB-93	--	--	RJ49C	6.0Y	02IS5
BRI-ST Card - NT7B76GY-93 (when connected to an NT1 which has a U interface to the telephone network)	--	--	RJ49C	6.0Y	02IS5
GATC LSDS (NT7B69AAAA) and GATC CI (NT7B75AAC)					

## Use of a music source

In accordance with U.S. Copyright Law, a license may be required from the American Society of Composers, Authors and Publishers, or similar organization if Radio or TV broadcasts are transmitted through the Music On Hold or Background Music features of this telecommunication system.

Nortel Networks hereby disclaims any liability arising out of the failure to obtain such a license.

## Rights of the telecommunications company

If the Norstar Compact ICS system is causing harm to the telephone network, the telecommunications company may discontinue service temporarily. If possible, the telecommunications company will notify you in advance. If advance notice is not practical, the user will be notified as soon as possible. The user will be given the opportunity to correct the situation and informed of the right to file a complaint to the FCC.

The telecommunications company may make changes in its facilities, equipment, operations or procedures that could affect the proper functioning of the system. If this happens, the telecommunications

company will give you advance notice in order for you to make any necessary modifications to maintain uninterrupted service.

## Repairs

In the event of equipment malfunction, all repairs to certified equipment will be performed by Nortel Networks or by one of its authorized dealers.

To return equipment for repair in the U.S., call 1-800-321-2649. You will receive a return advice number (RA#) to include with your returned equipment.

### Address of repair facilities

#### USA

Nortel Networks  
Nashville Repair Distribution Center  
640 Massman Drive  
Nashville, TN  
37210  
RA#\_\_\_\_\_

#### Canada

Nortel Networks  
30 Norelco Drive  
Weston, Ontario M9L 2X6  
Attn: Repair Department

## International regulatory

The CE marking on this equipment indicates compliance with the following EU directive: R&TTE Directive 99/5/EEC

This equipment meets the requirements of the following harmonized standards:

- EN60950: 1992 (Amendment 1 & 2)
- EN55022 Class A (1995), and EN50082-1 (1997)
- CTR 3 Amendment 1

# What's new with Norstar

The Norstar Compact ICS 6.0 software includes several new features and a few functionality changes.

## New features for version 6.0

- Distinctive ring for lines and hunt groups

You can now assign distinctive ring patterns (DRP) to both lines and hunt groups. This is similar to the feature that allows you to assign different rings to your telephone so you can distinguish which phone is ringing. All three of these features work in concert with each other. Which ring will be used depends on the priority that is assigned to each, and the order in which the assignment occurred. Refer to *Distinctive ring* on page 163 and *Assigning a distinctive ring pattern to a Hunt Group* on page 197.

- System wide call appearance feature codes (SWCA)

Sixteen new feature codes allow you to assign indicator memory buttons with SWCA codes. These buttons provide call appearance for both incoming and outgoing calls to any group of telephones with the same assigned buttons. This allows a call to be parked on a SWCA button, and then the call can be retrieved by any other member of the group.

Calls are assigned to the SWCA buttons, either automatically or manually, at the telephone that receives or makes the call. This frees up the line for other calls while maintaining an appearance of the call in the group. Refer to *Setting SWCA controls* on page 209.

- CLID display enhancements, alpha tagging using system speed dial, codes increased to 200

Alpha tagging is an enhancement to the CLID functionality of the system. This feature matches incoming calls with system speed dial entries. If enough digits match (CLID match), and the telephone is set to receive name display, then whatever name is entered into the system speed dial for that number will display as CLID when the call comes in. Refer to *Sys speed dial* on page 187.

**Note:** Alpha tagging activates when the CO line service supplies only a number for the incoming call. Otherwise, the system uses the name supplied by the CO line service.

To support this feature, the system speed dial codes have been increased to 200 entries, with three-digit codes from 001 to 255. Refer to the *Compact ICS 6.0 System Administrator Guide* for a detailed description of System Speed dial programming.

## Functionality changes for version 6.0

- Profile 2: This profile has been adjusted to accommodate systems which use ETSI PRI lines with an a-law companding protocol.
  - T1 functionality has been removed from this profile.
  - The central office ETSI PRI features: Network Call Redirection and Malicious Caller ID (MCID) can be used if they are allowed by your service provider. Refer to *ETSI: Network features (profile 2)* on page 235.
- Line renumbering: Due to the addition of ETSI to Profile 2, the line numbering for the entire system has been realigned to accommodate the extra lines provided by ETSI lines. This provides 30 lines per card on module 2 (card 1: 001-030; card 2: 031-060). This also means that the target lines have been renumbered to 061 to 086. When you perform an upgrade, existing line assignments will be automatically updated.
- Due to the expansion of the system speed dial feature codes up to 255, the personal speed dial list has been changed to codes 256 to 279 (24 codes (no change from existing systems)).

# Welcome to ISDN

This chapter provides you with some background information about ISDN and also includes information about:

- Analog vs. ISDN
- Type of ISDN service
- ISDN layers
- ISDN Bearer capability
- Services and features for ISDN BRI
- ISDN hardware
- ISDN standards compatibility

Integrated Services Digital Network (ISDN) technology provides a fast, accurate and reliable means of sending and receiving voice, data, images, text, and other information through the telecom network.

ISDN uses existing analog telephone wires and divides it into separate digital channels which dramatically increases the bandwidth.

ISDN uses a single transport to carry multiple information types. What once required separate networks for voice, data, images, or video conferencing is now combined onto one common high-speed transport.

**Note:** Nortel endeavours to test all variations of ISDN BRI and PRI on Norstar. However, due to the number of variations, this is not always possible. Check with your service provider about compatibility.

## Comparing ISDN to Analog

ISDN offers significantly higher bandwidth and speed than analog transmission because of its end-to-end digital connectivity on all transmission circuits. Being digital allows ISDN lines to provide better quality signaling than analog POTS lines and ISDN out-of band data channel signaling offers faster call set up and tear down.

While an analog line carries only a single transmission at a time, an ISDN line can carry one or more voice, data, fax and video transmissions simultaneously.

An analog modem operating at 14.4 K takes about 4.5 minutes to transfer a 1 MB data file and a 28.8 K modem takes about half that time. Using one channel of an ISDN line, the transfer time is reduced to only one minute. If two ISDN channels are used, transfer time is just 30 seconds.

When transmitting data, the connect time for an average ISDN call is about three seconds per call, compared to about 21 seconds for the average analog modem call.

## **BRI ISDN service**

Basic Rate Interface (BRI) ISDN service provides lines where each line is made up of separate channels known as B and D channels which transmit information simultaneously.

BRI is known as “2B+D” because it consists of two B-channels and one D-channel.

### **B channels**

B channels are the bearer channel and are used to carry voice or data information and have speeds of 64 kbps. Since each ISDN line (BRI) has more than one B-channel, a user can perform more than one transmission at the same time using a single ISDN line.

### **D channels**

The standard signaling protocol is transmitted over a dedicated data channel called the D-channel. The D-channel carries call setup and feature activation information to the destination and has speeds of 16 kbps. Data information consists of control and signal information and packet-switched data such as credit card verification.

---

## ISDN layers

ISDN layers refer to the standards established to guide the manufacturers of ISDN equipment. The layers include both physical connections, such as wiring and logical connections, which are programmed in computer software.

When equipment is designed to the ISDN standard for one of the layers, it works with equipment for the layers above and below it.

There are three layers at work in ISDN for Norstar. To support ISDN service, all three layers must be working properly.

- **Layer 1:** A physical connection that supports fundamental signaling passed between the ISDN network (your service provider) and the Norstar ICS. When the BRI card LED for a loop which is used for a network connection is lit, layer 1 is functioning.
- **Layer 2:** A logical connection between the ISDN network (your service provider) and the Norstar ICS. Norstar has two of these connections for each BRI line, one for each of the logical lines. Without Layer 2, call processing is not possible and there is no dial tone.
- **Layer 3:** Also a logical connection between the ISDN network (your service provider) and the Norstar ICS. For BRI lines, layer 3 is where call processing and service profile identifier (SPID) information is exchanged. This controls which central office services are available to the connection. For example, a network connection can be programmed to carry data calls.

The system of layers is important when you are installing, maintaining, and troubleshooting an ISDN system. See *Problems with BRI service* on page 274 for more information about working with the layers.

## ISDN Bearer capability

Bearer capability describes the transmission standard used by the BRI line so that it can work within a larger ISDN hardware and software network.

The bearer capability for BRI is voice/speech, 3.1 kHz audio, and data (unrestricted 64 kbps, restricted 64 kbps, 56 kbps).

## Services and features for ISDN BRI

As part of an ISDN digital network, your Compact ICS supports enhanced capabilities and features, including:

- faster call set up and tear down
- high quality voice transmission
- dial-up Internet and local area network (LAN) access
- video transmission
- network name display
- name and number blocking (BRI and analog)
- access to public protocols (NI-1 for BRI)

### BRI services and features

- data transmission at speeds up to 128 kbps per loop (depending on the bandwidth supported by your service provider)
- shared digital lines for voice and data ISDN terminal equipment

Norstar Basic Rate Interface (BRI) cards also support D-channel packet service between a network and terminal connection. This allows you to add applications, such as point-of-sale terminals, without additional network connections.

Any analog or digital network connections can be shared by all Norstar telephones, peripherals and applications, and ISDN terminal equipment (TE).

Compact ICS supports the following ISDN services and features offered by ISDN service providers:

- D-channel packet service to support devices such as transaction terminals. Transaction terminals are used to “swipe” credit or debit cards and transmit the information to a financial institution in data packets.
- calling number identification (appears on both Norstar sets and ISDN terminal equipment with the capability to show the information)
- Multi-Line Hunt or DN Hunting, which switches a call to another ISDN line if the line usually used by the Network DN is busy.



- subaddressing of terminal equipment (TE) on the same BRI loop. However, terminal equipment which supports sub-addressing is not commonly available in North America.

Transmission of B-channel packet data is not supported by Compact ICS.

Contact your ISDN service provider for more information about these services and features. Packages for ISDN service in North America are described on page 32.

The terminal equipment (TE) connected to the Norstar system can use some feature codes supported by the ISDN service provider. See *ISDN services and features* in the *Compact ICS 6.0 System Coordinator Guide* for more information.

## Network name display

When your phone rings, this feature allows you to see the name of the person that is calling you. This call information is only available from the public network and must be activated on the public network side of the switch.

## Name and number blocking

This feature allows you to program a feature button with the code from the CO that is used to suppress the outgoing name and/or number. For information on system programming of this feature see, *Outgoing Name and Number Blocking* on page 240.

## MCID (ETSI system feature)

The MCID feature allows you to use     to have call information recorded on the central office database for an incoming call on a specific line (EUROISDN lines, only).

The user must invoke the feature code without hanging up, and within 30 seconds (time varies on different networks) after the caller hangs up.

## Network Call Diversion (ETSI system feature)

This feature is a network function of ETSI E1 lines that allows forwarding and redirection of calls outside the Norstar network when using an ETSI ISDN line. Functionality is similar to that of External Call Forward (ECF). NCD redirects calls using the same line on which they arrive. Call forward is efficient since there is no need for additional outside lines.

## ISDN hardware

To support connections to an ISDN network and ISDN terminal equipment, your Compact ICS must be equipped with one or more BRI Cards (BRI-U or BRI-ST).

### BRI Card

The loops on BRI-U and BRI-ST Cards can be programmed to support either network or terminal connections. This allows you to customize your arrangement of lines, voice terminals, data terminals and other ISDN equipment. This section describes some basic hardware configurations for network and terminal connections for each loop type.

For detailed wiring information for BRI network and terminal connections see *Installation* on page 67.

### BRI-U2 and BRI-U4

A BRI-U2 Card supports two loops and the BRI-U4 supports four loops. Each loop can be individually programmed to provide:

- a U-LT reference point connection for terminal equipment (TE) with built-in NT1 functionality (U interface), or
- a U-NT reference point connection for direct connection to an ISDN network

### BRI-ST Card

A BRI-ST Card provides four loops. Each loop can be individually programmed as:

- an S reference point connection (S loop) to ISDN terminal equipment (TE), or
- a T or S reference point connection (T loop or S loop) to an ISDN network using an external NT1

## U-LT reference point

The U-LT reference point connection provides a point-to-point digital connection between Norstar and TE equipped with a U interface.

A U-LT loop supports up to eight ISDN DN's, which identify TE to the ICS.

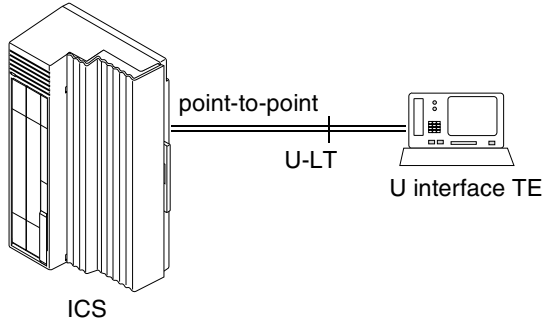

## U-NT reference points

The U-NT reference point connection provides a point-to-point digital connection between the ISDN network and the ICS.

A U-NT loop provides lines that can be used by all Norstar telephones, peripherals and applications, and ISDN TE.

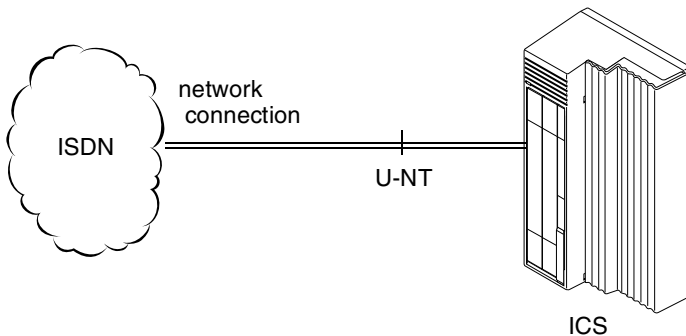

U-NT and U-LT loops can be used in combination to provide D-packet service for a point-of-sale terminal adapter (POSTA) or other D-packet device. D-packet service is a 16 kbps data transmission service that uses the D-channel of an ISDN line.

To deliver D-packet service, a network connection (U-NT) is programmed to work with a terminal connection (U-LT). The loops must be on the same physical card. For example, if the network connection is a loop found on the BRI Card in Slot 1, the terminal connection must be a loop found on the same card.

## S reference point

The S reference point connection provides a point-to-point digital connection between Norstar and ISDN terminal equipment (TE) that uses an S interface.

S loops support up to seven ISDN DNs, which identify TE to the ICS.

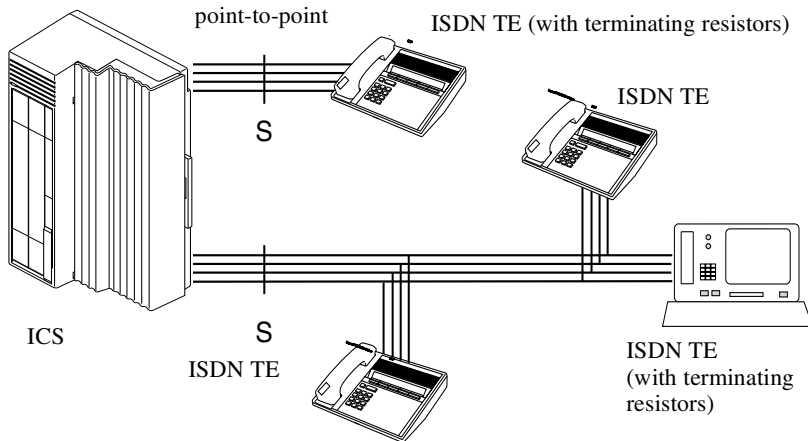

## T reference points

The T reference point connections provide a point-to-point digital connection between the ISDN network and Norstar.

A T loop provides lines that can be shared by all Norstar telephones, peripherals and applications, and ISDN TE.

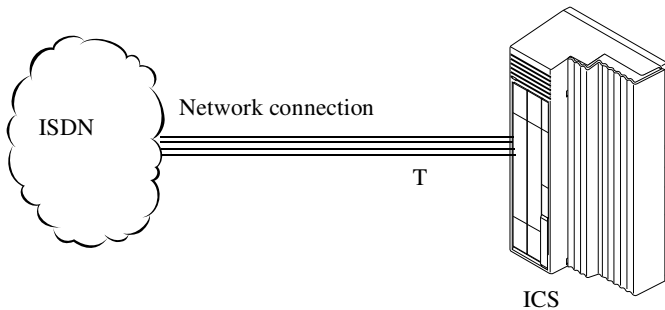

An T loop can be used in combination with an S loop to provide D-packet service for a point-of-sale terminal adapter (POSTA) or other D-packet device. D-packet service is a 16 kbps data transmission service that uses the D-channel of an ISDN line.

To deliver D-packet service, a network connection (T loop) is programmed to work with a terminal connection (S loop). The loops must be on the same physical card. For example, if the network connection is a loop found on the BRI Card in Slot 1, the terminal connection must be a loop found on the same card

## Clock Source for ISDN Cards

Systems with ISDN interfaces need to synchronize clocking with the ISDN network and any connected ISDN terminal equipment. Clocking synchronization is supported by a Services Cartridge.

The Compact ICS derives timing from the network using U-NT and T reference points (loops). Terminal equipment on U-LT and S reference points (loops) derive timing from the ICS.

Systems synchronize clocking to the first available, functional, network connection. If there are excessive errors on the reference network connection, or the loop fails, the next available, functional, network connection is used for clock synchronization.

When you configure the network connections to the Compact ICS, you should take into account the system preferences for selecting loops for synchronization:

- lower numbered loops have preference over higher numbered loops
- the loop preference order is: 201, 202, 203, 204, 231, 232, 233, 234
- the system skips U-LT, S, and analog loops when selecting a network connection for synchronization

Systems with only U-LT and S loops act as timing masters for the attached terminal equipment (TE), and are not synchronized to the network. ISDN TE without access to a network connection (BRI lines) has limited or no functionality.

## Other ISDN BRI equipment

### NT1

The NT1 (network termination type 1) connects an S interface (four-wire) to a U interface (two-wire). In most cases, it connects loops from a BRI-ST card to the network connection, which uses the U interface. It can also connect S interface terminal equipment (TE) to the U loop from a BRI-U2 or BRI-U4 Card.

An NT1 is not required to connect from the network to BRI-U Cards or to connect U interface TE to an ICS equipped with BRI-U Cards.

The NT1 converts and reformats data so it can be transmitted to and from the S or T connection. In addition, it manages the maintenance messages travelling between the network and the NT1, and between the NT1 and the ICS.

The NT1 from Nortel Networks is packaged two ways:

- a stand-alone package which contains one NT1 card (NTBX80XX) and a power supply (NTBX81XX)
- a compact package which contains up to 12 NT1 cards (NTBX83XX) and a power supply (NTBX86AA)

---

## ISDN standards compatibility

Norstar ISDN equipment supports National ISDN standards for basic call and calling line identification services.

Norstar BRI is compliant with National-1.

## Planning your ISDN network

Consult *ISDN hardware* on page 26 and *ISDN programming* on page 33 to determine a configuration of ISDN trunks and terminal equipment (TE) for the Compact ICS, then order the appropriate ISDN capability package from your ISDN service provider.

For ISDN BRI service your service provider supplies service profile identifiers (SPIDs), network directory numbers (Network DNs), terminal endpoint identifiers (TEIs), and other information that is required to program your Compact ICS, TE and other ISDN equipment.

Compact ICS does not support any package with EKTS (Electronic Key Telephone System), CACH (Call Appearance Call Handling), or Calling Name Display. EKTS is a package of features provided by the service provider and may include features such as Call Forwarding, Link, Three-Way Calling, and Calling Party Identification.

## Ordering ISDN BRI

### Ordering service in Canada

In Canada, order Microlink™ service, the trade name for standard BRI service. You can order either regular Microlink™ service, which includes the CLID (Calling Line Identification) feature, or Centrex Microlink™, which includes access to additional ISDN network features (including Call Forwarding).

When ordering Microlink™ service, it must be ordered with EKTS (Electronic Key Telephone System) turned off. If you will be using a point-of-sale terminal adapter (POSTA), ask for D-packet service to be enabled.

## Ordering ISDN service in the U.S.

In the U.S., regardless of the CO (Central Office) type, order National ISDN BRI-NI-1 with EKTS (Electronic Key Telephone System) turned off. Use the following packages as a guideline for ordering your National ISDN BRI-NI-1. However we recommend using packages M or P with the Compact ICS. Contact your service provider for more information about the capability packages it offers. Bellcore/National ISDN Users Forum (NIUF ISDN packages supported by Compact ICS (for ordering in U.S.))

	<b>Capability</b>	<b>Feature set</b>	<b>Optional features</b>	<b>Point -of-sale</b>	<b>Voice</b>	<b>Data</b>
M	Alternate voice/circuit-switched data on both B-channels	--	calling line identification	--	⊕	⊕
P	Alternate voice/circuit-switched data on both B-channels D-channel packet	flexible calling for voice (not supported by Compact ICS) Basic D-Channel Packet	additional call offering (not supported by Compact ICS) calling line identification	⊕	⊕	⊕

If you want to transmit both voice and data, and support D-channel packet service, order package P. However, Compact ICS does not support the flexible calling for voice and additional call offering features that are included in package P.

Multi-Line Hunt may be ordered with your package. When a telephone number (the Network DN) in the group of numbers assigned by your service providers is busy, the Multi-Line Hunt feature connects the call to another telephone number in the group. Norstar supports the feature only on point-to-point, network connections (T loop or U-NT loop). Check with your service provider for more information about Multi-Line Hunt.



Any of the ISDN packages will allow you to use sub-addressing, but your ISDN TE must be equipped to use sub-addressing for the feature to work.

## ISDN programming

Most of the configuration programming for BRI lines and ISDN terminals and devices is done under Hardware. This section gives you an overview of programming for BRI lines, ISDN terminals and devices, and D-packet service.

BRI programming activity	Programming heading
View or change the card configuration for each slot in the ICS	Hardware
Provision or pre-provision loops and lines	Provisioning
Enable or disable BRI card	Module status
View status of line, loop or port	Port/DN status

### Programming ISDN BRI resources

Some steps will not be necessary, depending on the service you are providing.

More detailed information is included under the individual headings and settings in the Programming and Maintenance sections.

For complete card and cartridge installation instructions and safety precautions, see *Installation* on page 67.

1. Collect the information supplied by your service provider to support your ISDN package. This includes network service profile identifiers (SPIDs) and Network DNs. If you are supporting a point-of-sale terminal adapter, you also need one or more terminal endpoint identifiers (TEIs).
2. Make sure a Combination Fiber 6-port Services Cartridge, or a Services Cartridge is installed in the ICS.
3. Install the BRI card in the ICS, Trunk Module (see *Installing the cartridges* on page 72 for information about BRI card placement), or determine which type of card you will preprogram the ICS to use in each slot.

4. Disable each card under Maintenance.
5. Select a card type (BRI-ST, BRI-U2, BRI-U4) in Hardware.
6. Select the type for each loop in Hardware:

For a BRI card select T or S if the card type is BRI-ST. Select LT or NT if the card type is BRI-U2 or BRI-U4.
7. If the card uses an S, T or NT loop, enter the following configuration information as supplied by your service provider:
  - the SPID assigned to the loop, the number of B-channels associated with each SPID, the Network DNs used with the network SPID, and the call type of the Network DN. Repeat the programming for the second network SPID, if any.
  - If the S, T or NT loop is used for D-packet service: turn on the service, assign the appropriate S loop mapping (for BRI-ST cards) or LT-loop mapping (for BRI-U2 or U4 cards), and assign the TEIs (provided by the telco to support a point-of-sale terminal adapter or other D-packet service device) to the loop.
  - If the loop type is S, select the sampling used on the loop.
  - If the loop type is S or LT, assign ISDN DNs to the loop and designate one of the assigned ISDN DNs to be the DN for the loop (Loop DN).

**Note:** You can have a maximum of 30 ISDN DNs on your system. The default ISDN DN range is 273–304. To change ISDN DN type, see *Change DNs* on page 200

8. Re-enable the card in Maintenance. If required, the card goes through a firmware download process, which takes five to six minutes. During a firmware download, the bottom LED on the BRI Card flashes.
9. Provision the loops and lines, as appropriate, in Maintenance programming. Refer to *Provisioning* on page 308
10. If you are configuring auto-answer BRI trunks to map to target lines, program the received number for the target line (a setting found under Lines) to be the same as the Network DN supplied by your service provider.
11. Assign the ISDN lines and target lines to the appropriate ISDN DNs (the set of DNs reserved for use by ISDN devices) under Line access, a subheading of Terminals&Sets. ISDN lines can also be assigned to the DNs used by Norstar telephones or any other devices connected to the Compact ICS.

12. Program the ISDN terminals and devices with the appropriate ISDN DNs and terminal SPIDs by following the instructions that come with the devices. For more information see *Programming ISDN equipment* on page 36.

If you are setting up a D-packet service, program the point-of-sale terminal adapter or other D-packet service device with the appropriate TEI (provided by your service provider), terminal SPID, and DN by following the instructions that come with the device.

## Programming ISDN BRI lines

When the configuration programming under Hardware is complete, your BRI lines are ready to be programmed in the same way as analog lines. You can, for example, place them in pools and assign them to Norstar sets and ISDN terminal equipment. However, there are some differences in the way BRI lines work that will influence how you configure them to handle incoming and outgoing calls.

For BRI lines, in most cases, your service provider supplies two SPIDs – one for each B channel. Each SPID and one or more Network DNs are associated with a single line. Calls to a Network DN come in on a specific line, and pressing a line button selects the same line every time.

If your service provider supplies you with a single SPID for both B channels, incoming and outgoing calls are handled according to the loop. The two lines provided by the BRI loop are “pooled” for both incoming and outgoing calls.

For example, if Loop 201 is programmed with a single SPID, which supports lines 001 and 002, incoming calls made to a Network DN associated with the SPID appear on either line 001 or line 002. If you press the line button for line 001, either line 001 or line 002 is selected. For loops which use a single SPID, assign both lines on a loop to a set to guarantee that all calls appear at the set.

## Programming ISDN equipment

### Terminal equipment for BRI cards

Unlike Norstar sets, ISDN devices and terminals connected to the ICS must be configured under the Hardware heading in system programming. You choose directory numbers for ISDN equipment from a pre-determined range of DNs (273-304). Any of the ISDN DNs can be assigned to any U-LT or S loop, but each can only be assigned to one loop and a single device.

### Devices on an S or LT loop (BRI cards only)

Terminal equipment using a U-LT loop or S loop must be assigned an ISDN directory number (ISDN DN). This allows the TE to be assigned lines and to communicate with other devices connected to the ICS. Each DN can be assigned to only one TE and to one loop.

You assign ISDN DNs to S loops and LT loops under Assign DNs in Hardware programming. Each S or LT loop can be programmed with eight ISDN DNs, but you cannot exceed a total of 30 ISDN DNs for the Compact ICS.

Once you have assigned ISDN DNs to a loop, designate one of the DNs as a Loop DN. The Loop DN acts as a main ISDN DN and completes the configuration of the loop.

The ISDN terminal equipment (TE) on the loop is also programmed with its ISDN DN. See the instructions that come with the ISDN device for information on how to program it to recognize its assigned DN. Most devices will require both a terminal service profile identifier (terminal SPID) and a DN. Some will require two terminal SPIDs and two ISDN DNs. The SPID used with the device should not be confused with a SPID used for network connections using an T or NT loop.

To create a terminal SPID for a device, add at least two zeros to the end of the of the ISDN DN. Add more zeros to the beginning or end of the ISDN DN until you have the length of SPID required by the TE. For example, if an ISDN telephone requires a six-digit SPID and has a DN of 73, its SPID is 007300. If the same TE requires a minimum of 10 digits, the SPID is 0000007300.

Most ISDN terminals require a five-digit SPID. An ISDN computer card usually requires a 10-digit SPID. Follow the directions that come with the ISDN device to program it with a SPID and ISDN DN.

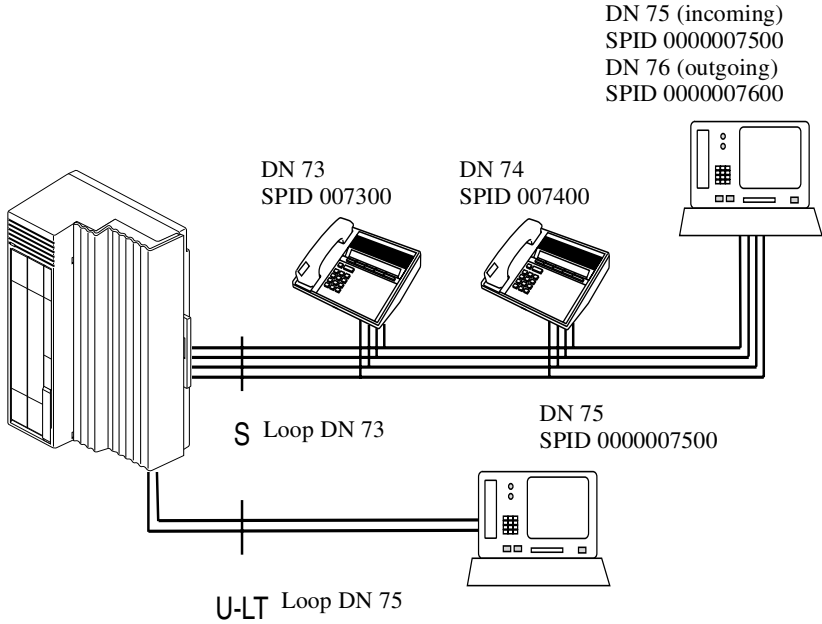

The following table uses the example in the illustration to show the programming for the S loop.

Setting	Option
Loop	201
Type	S
Sampling	Fixed
DNs on Loop 201: Assign DNs	73: Assigned 74: Assigned 75: Assigned 76: Assigned
Loop DN	73

## ISDN router

By connecting an ISDN router to your Compact ICS, a group of computers can share Internet access. This arrangement is best for a workplace where each computer occasionally uses an Internet connection.

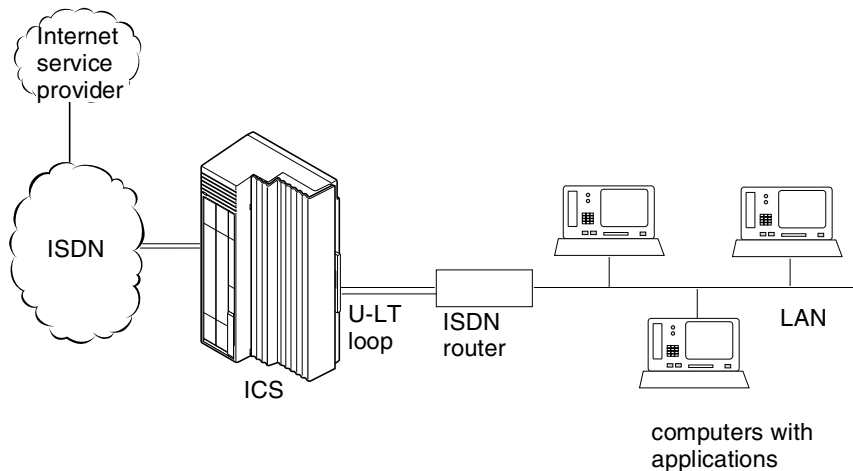

To support Internet access, you must order BRI lines from your service provider, and subscribe to Internet service from an Internet service provider (ISP). Your computers must have an Internet browser and any applications supplied by your ISP.

## D-packet service (BRI cards only)

The D-packet service supplied by the Compact ICS supports a point-of-sale terminal adapter (POSTA). Connecting a POSTA allows transaction terminals (devices where you “swipe” credit or debit cards) to transmit information using the D channel of the BRI line, while the B channels of the BRI line remain available for voice and data calls. A special adapter links transaction equipment (such as cash registers, credit card verification rigs, and point-of-sale terminals) to the X.25 network, a data communications network designed to transmit information in the form of small data packets.

To support the D-packet service, your ISDN network and financial institution must be equipped with a D-packet handler. To convert the protocol used by the transaction equipment to the X.25 protocol, your

ISDN network must also be equipped with an integrated X.25 PAD which works with the following versions of X.25: Datapac 32011, CCITT, T3POS, ITT and API. The ISDN service package you order must include D-packet service (for example, Package P in the U.S.; Microlink™ with D-channel in Canada).

Your service provider supplies a Terminal Endpoint Identifier (TEI) and DN to support D-packet service. The TEI is a number between 00 and 63 (in Canada, the default range is 21-63). Your service provider may also supply you with a DN to program your D-packet device. The DN for D-packet service becomes part of the dialing string used by the D-packet to call the packet handler.

## **POSTA for ISDN BRI**

When you configure D-channel packet service, you are specifying the transmission path between an ISDN loop on the network side of the ICS and the ISDN loop on the set side (the loop used by the point-of-sale terminal adapter). The service is turned on and configured using the network loop programming found under Hardware (NT loop for BRI-U2 and BRI-U4 Cards; S or T loop for BRI-ST Cards).

To set up D-packet service:

- go to the programming settings for the network loop (S, T, or NT loop) under Hardware
- select the S loop or LT loop used by the POSTA
- enter the terminal endpoint identifiers (TEIs) supplied by your service provider

## **Point-of-sale terminal adapter**

The point-of-sale terminal adapter is an analog device that connects to point-of-sale devices using an RS-232 interface and a U-LT loop. It handles the routing of packet information from the devices to the ICS and into the ISDN network.

Your service provider (usually a financial institution) supplies you with information about the compatible controller, which handles the routing of packet information from the devices to the ICS and into the ISDN network.





# Networking with Norstar

In addition to public network connections, Norstar Compact ICS can be integrated into an existing private network or to other Norstar systems to form a corporate telecommunications network.

## The big picture

Norstar uses enhanced trunking to join other Norstar or customer equipment in a private network. Authorized users can also access central office lines and Norstar features from outside their Norstar system.

Callers using the Norstar Compact ICS system can

- call directly to a specific Norstar telephone
- select an outgoing central office line to access the public network
- use all of the Norstar features

Callers in the public network can

- call into the Norstar Compact ICS system and select an outgoing central office line to access the public network
- call into the Norstar Compact ICS system and use remote features

## Norstar behind a PBX

Norstar Compact ICS can be used behind a PBX. In order to support this application, the trunk lines must be set up not to exceed 8 dB total loop loss from the serving central office to the connection point at the Norstar ICS.

# Trunks and target lines

---

Trunks are external lines that provide the physical connection between a Norstar system and other systems in a private or public network. Norstar Compact ICS supports two different types of trunks:

- Loop start trunks handle incoming and outgoing calls between Norstar and the public network. They are numbered 001-004 and 031-034.
- BRI trunks handle incoming and outgoing calls between Norstar and an ISDN network. They are numbered from 001-008 and 031-038.

Target lines are virtual communication paths between trunks and telephones on the Norstar system. They are incoming lines only, and cannot be selected for outgoing calls. You can use target lines to simulate direct inward dialing (DID) service by routing calls to telephones according to the digits received from the central office on a BRI trunk.

Target lines are numbered 061 to 086. Telephones can be configured to have an appearance of any type of trunk and line (including target lines).

## Loop start trunks

Loop start trunks provide incoming and outgoing access to the public network. Loop start trunks can be configured as manual-answer or auto-answer. The answer mode determines how the system handles incoming calls.

When a call comes in on a manual-answer loop start trunk, it alerts at all telephones with that line appearance.

When a call comes in on an auto-answer loop start trunk that is configured to answer with direct inward system access (DISA), the caller hears a stuttered dial tone. They must enter a six-digit Class of Service (COS) password from a dual tone multifrequency (DTMF) telephone to access system dial tone. Once the caller has system dial tone, they can then enter a target line number, a line pool access code or a remote feature code.

By default, auto answer loop start trunks are configured to answer with DISA, and are used to provide controlled access to Norstar system resources.

When a call comes in on an auto-answer loop start trunk that is not configured to answer with DISA, the caller hears system dial tone. They can then enter:

- a target line number
- a DISA DN, which is the number that will prompt for a COS password
- a line pool access code
- a remote feature code from a DTMF telephone

To place an outgoing call, a loop start line can be selected by pressing a line button on the telephone, dialing a line pool access code, or pressing a memory button that has been programmed with a line pool access code.



**Tip** - Loop start signaling is supported by Loop Start / Disconnect Supervision (LS/DS) Analog Trunk Cartridges and Call Information (CI) Trunk Cartridges. Each LS/DS Analog Trunk Cartridge or CI Trunk Cartridge can provide four loop start trunks. To configure the loop start trunks as auto-answer, the trunks must have disconnect supervision enabled. The central office must provide far end disconnect supervision.

The default programming for trunks uses disconnect supervision. If the central office does not provide far end disconnect supervision, the Trunk Mode setting in Lines programming should be changed to unsupervised.

You may configure a loop start trunk as the prime line for a Norstar telephone. The prime line is the line the telephone uses automatically if no other line is chosen or no line pool is entered.

The capabilities available to a remote caller are determined by the remote restrictions and remote package assigned to a line, or by the set restrictions, line restrictions and remote package assigned to the COS password.

Callers can also access the system by using the Auto Attendant features. See the Compact ICS Coordinator Guide for more information.

## BRI trunks

BRI trunks give you incoming and outgoing access to an ISDN network. Like loop start trunks, they can be configured as manual-answer or auto-answer. See the Loop start trunks information that starts on page 42 for information on setting the answer mode.

BRI trunks provide a fast, accurate and reliable means of sending and receiving data, images, text and voice information. Using BRI lines allows for faster transmission speeds and the addition of a variety of powerful business applications, including remote LAN access, video conferencing, file transfer and Internet access.

For more information see *Welcome to ISDN* on page 21.

## Target lines

A target line is a specific communication path that is reached by means of digits received from an incoming BRI trunk. Target lines are used to answer incoming calls but cannot be used to make outgoing calls.

You can program auto-answer BRI trunks to map to target lines to provide for attendant bypass (calling directly to a department or individual) and line concentration (one trunk can map onto several target lines).

No target lines are assigned to sets by default.

Target lines are referred to by line numbers (061-086) in the same way as physical lines.



### ***Privacy issue***

You can set a target line to Private (default is Public), however, such features as Call Pickup can still answer these lines at remote telephones.

---

# Remote system access

---

The remote access feature allows callers elsewhere on the public network to access a Norstar system directly without going through an attendant. Once in the system, the remote user can use some of the system's resources. The remote access must be enabled in programming before callers can use it.

Norstar Compact ICS systems support remote system access on auto-answer loop start trunks and can require the remote caller to enter a (COS) password for direct inward system access (DISA).

The system resources —dialing capabilities, line pool access and feature access — that a remote user may access depends on the Class of Service (COS) assigned to them. See the description of COS on page 46 for more details.

To use features on a Norstar system remotely, press  followed by the feature code. Even if you are calling from another Norstar system, press  instead of .

## Remote access on loop start trunks

Loop start trunks provide remote access to the Norstar system from the public network and must be configured as auto-answer in Lines programming to provide remote system access.

A loop start trunk must have disconnect supervision enabled if it is to operate in auto-answer mode.

When a caller dials into the system on a line that has auto-answer, the system answers with system dial tone and no COS password is required. In this case, control over the system capabilities available to the caller is provided only by the restriction filters assigned to the line.

When a caller dials in on a line that has auto-answer with DISA, the system answers with stuttered dial tone. This is the prompt to enter a COS password, which determines which system capabilities are available to the caller.

# Networking features

---

## Security

Programming provides several ways of protecting your Norstar system from unauthorized access or use.

### Class of Service

Class of Service (COS) refers to the capabilities that Norstar provides to users who access the system from the public or a private network.

The COS includes:

- filters that restrict dialing on the line
- an access package, which defines the set of line pools that may be accessed and whether or not the user has access to the paging feature.

The COS that is applied to an incoming remote access call is determined by:

- the filters that you apply to the incoming trunk
- the COS password that the caller used to gain access to the Norstar system.

In cases where DISA is not automatically applied to incoming calls, the remote caller can change the COS by dialing the DISA DN and entering a COS password.

To program COS passwords, see *COS pswds* on page 188 in this guide.

### Restriction filters

Restriction filters can be used to restrict the numbers that may be dialed on any external line within the Norstar system. Up to 100 restriction filters can be created for the system. A restriction filter consists of up to 48 restrictions and their associated overrides.

To restrict dialing within the system, you can apply restriction filters to:

- outgoing external lines (as line restrictions)
- telephones (as set restrictions)
- external lines on specific telephones (as line/set restrictions)

Restriction filters can also be specified in Restrictions service for times when the system is operating according to a schedule. Refer to the description in *Services* on page 168 for more details.

## Calling out

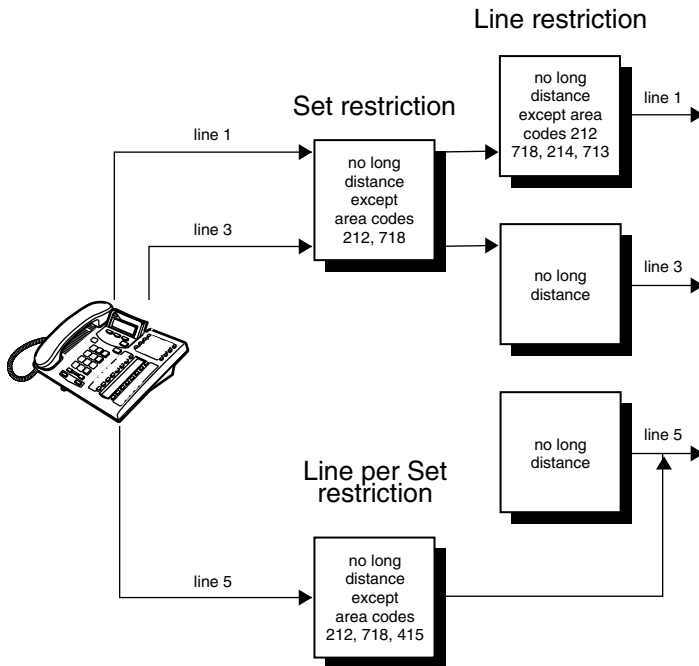

Dialed digits must pass both the line restrictions and the set restrictions. The line per set (line/set) restriction overrides the line restriction and set restriction.

In this diagram, a caller using line 001 could only dial long-distance numbers to area codes 212 and 718. A caller using line 003 could not dial any long-distance numbers. A caller using line 005 could dial long-distance numbers to area codes 212, 718, and 415.



**Tip** - To restrict dialing from outside the system (once a caller gains remote access), apply restriction filters to incoming external lines (as remote restrictions).

## Calling in

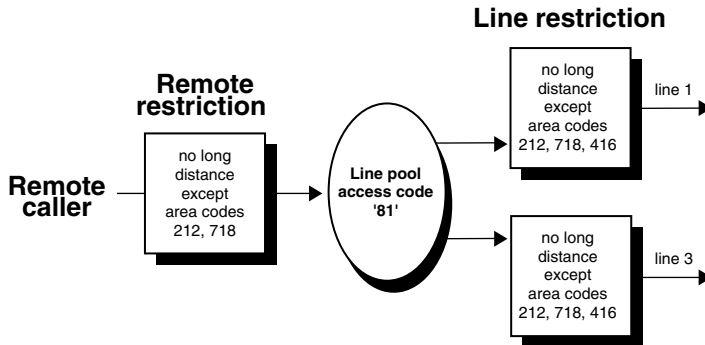

In this case, dialed digits must pass both the remote restriction and the line restriction. A remote caller can override these filters by dialing the DISA DN and entering a COS password.

For restriction filter programming instructions, see *Restrtn filters* on page 164 in this guide.

## Direct inward system access (DISA)

To control access from the public network, configure auto-answer trunks to answer with DISA. Remote callers hear a stuttered dial tone and must then enter a COS password that determines what they are allowed to do in the system.

Auto-answer loop start trunks are configured to answer with DISA by default. For DISA programming instructions, see *Trunk/Line data* under *Lines* on page 155 in this guide.



## Transparent dialing plan



The Norstar system has a routing feature that allows you to set up a transparent or coordinated dialing plan with other systems in the public network. The goal is to have a network-wide dialing plan where all telephone numbers are unique and of a uniform length.





Dialing plans are typically used with a network of systems with a three to seven digit dialing access between them.

Any programming for routing should be carefully planned using the tables supplied with the *Programming Record*. The settings for routing and destination codes are fully explained under *Routing service* on page 172. This section deals with applying the programming in network situations.

### Dialing plan using public lines

The following illustrations show the *Programming Record* for a Toronto system in a network of three offices: Toronto, Halifax and Vancouver. Without routing, a Norstar user in Toronto would have to select a line pool and dial 1-902-585-3027 to reach extension 27 in Halifax (902). By creating a destination code of 30 and creating a route that uses the proper line pool and DialOut, the user simply dials 3027. The same feature is available for Vancouver (604).

In the DialOut, P stands for pause, a host system signaling option. Press    to insert a 1.5-second pause in the dialing string. See the *System Coordinator Guide* for information about other signals.

Routing Service (Services: Routing Service)		
Route # (000-999)	DialOut (if required) (max. 24 digits or characters)	Use Pool
100	1-P-902-585	 B C
101	1-P-902-585	 B C
102	1-P-604-645	 B C
103	1-P-604-645	 B C
		 B C

Note that, in this case, only the Normal schedule is being used.

Routing service (continued)								
Dest code (Services: Routing service: Dest codes)								
Service Schedule	Normal		Sched 1		Sched 2		Sched 3	
Sched name (max. 7 char.)	Normal		Night		Evening		Lunch	
DestCode (max. 7 digits)	<b>Use route</b> (001-999)	<b>Absorb Length</b>	<b>Use route</b> (001-999)	<b>Absorb Length</b>	<b>Use route</b> (001-999)	<b>Absorb Length</b>	<b>Use route</b> (001-999)	<b>Absorb Length</b>
30	<del>000</del> 100	All 0	000	All	000	All	000	All
31	<del>000</del> 101	All 0	000	All	000	All	000	All
32	<del>000</del> 102	All 0	000	All	000	All	000	All
33	<del>000</del> 103	All 0	000	All	000	All	000	All

## Destination code numbering in a network

Because the system checks the initial digits of a call against the routing tables, each type of internal or external call must begin with a unique pattern of digits. The following table gives a sample plan for how initial digits are assigned in a network of systems with three-digit intercom numbers.

Leading Digits	Use
0	Network Direct Dial
221-253	Intercom calls
4	Coordinated Dialing Plan
5	Unused
6	Unused
8	Call Park Prefix
9	All PSTN Calls

In the table, 4 is used as the initial digit for the coordinated dialing plan, but 5, or 6 could also be used for this purpose.



**Tip** - *When programming a button to dial a Network number automatically (autodial), network calls must be treated as external numbers, even though they resemble internal extension numbers.*

*Routes generally define the path between the Norstar system and another switch in the network, not other individual telephones on that switch.*



# Data Solutions

## Examples of ISDN Scenarios

For information on various ISDN scenarios that may help you to decide on the data solution that is best for you, refer to the following web site: <http://www.nortelnetworks.com/support> and perform a Search for **TIPS**. You will need your user name and access code.

If you do not have a user name and access code, the site provides information about how to get access to this site.

## ISDN applications

ISDN terminal equipment delivers a wide range of powerful business applications:

### Video conferencing and video telephony

Video conferencing offers instant visual and audio contact between distant parties using either studio-based or desktop ISDN terminals.

### Desktop conferencing

ISDN allows computer users in distant locations to share and edit any image, data or text file on their own computer screens while they discuss the information.

### File transfer

The ISDN network allows you to transfer files containing data, text, images, data, or audio clips, faster and cheaper than with a conventional modem.

## **Telecommuting**

Convenient retrieval, processing and storage of files is possible for the employee working at home by using ISDN lines to give high-speed access to information resources at the office.

## **Group 4 fax**

ISDN fax applications save money by increasing both transmission speed and the quality of resolution.

## **Remote LAN access**

ISDN provides an affordable and fast means for employees at remote sites, such as at home or in branch offices, to access local area networks (LANs).

## **Leased line backup**

Essential backup for leased lines can be provided using ISDN as required, rather than duplicating costly permanent leased lines.

## **LAN to LAN bridging**

Local area network (LAN) bridge/routers allow flexible interconnection between LANs using ISDN, with charges only incurred when information is actually transmitted.

## **Internet and database access**

The fast call set up and high bandwidth of ISDN are ideal for accessing information services such as the Internet and databases.

# Planning the installation



**Only qualified persons should service the system.**

The installation and service of this unit is to be performed only by service personnel having appropriate training and experience necessary to be aware of hazards to which they are exposed in performing a task and of measures to minimize the danger to themselves or others.

## Planning checklist

- Consult the table *Installing the cartridges* on page 72 to verify that you have the proper Compact ICS 6.0 software cartridge configuration.
- Verify that you have all the equipment and supplies you need to install the system.
- Determine the location for the Integrated Communication System (ICS) hardware, telephones, and other equipment.
- Select the template to be used in System Startup. See *Startup programming* on page 130.
- Plan and record system programming details in the *Compact ICS 6.0 Programming Record*.

## Equipment and supplies

- Optional configuration for programmable Auto Attendant prompts
- Integrated Communication System (ICS)
- Feature Cartridge
- Trunk Cartridge(s) for the ICS (as required)
- BRI Card(s) for the ICS (as required)
- Norstar telephones
- ISDN devices (for example, terminal equipment, data devices), as required
- Expansion Cartridge (8 port, for analog only systems)

- Expansion Cartridge with Clocking (8 port, for systems using BRI)
- Clocking Cartridge (for systems using BRI, no additional set ports)
- distribution panel(s)

The ICS supports up to 24 Norstar telephones (30 telephones, for profile 2 ETSI configurations). You must install an Expansion Cartridge with Clocking or a Clocking Cartridge to use BRI Cards.

## Optional equipment

- station auxiliary power supply (SAPS)
- Busy Lamp Field (BLF)
- central answering position (CAP) module
- analog terminal adapter (ATA)
- uninterruptible power supply (UPS)
- analog emergency telephone
- Digital Network Adapter
- other

## Equipment for installing the ICS

- screwdriver
- pliers
- connecting tool
- two 19 mm (3/4 in.) wood screws for the mounting bracket
- one 32 mm (1-1/4 in.) wood screw for the bottom mounting tab
- 19 mm (3/4 in.) wood backboard (if necessary)



## Location requirements

- clean, dry, and well-ventilated to allow free airflow
- minimum clearance of 150 mm (5 in.) above and 100 mm (4 in.) below the ICS
- the gap between the ICS and the wall should be left completely clear to allow proper heat dissipation
- temperature between 0°C and 50°C (32°F and 122°F)
- humidity between 5% and 95%, non-condensing
- minimum distance of 4 m (13 ft) from equipment such as photocopiers, electrical motors and other equipment that can produce electromagnetic, radio-frequency, and electrostatic interference

## Electrical requirements

- non-switched, unobstructed outlet within 1.5 m (5 ft) of the ICS
- dedicated 110 V - 120 V ac nominal, 50/60 Hz, 15 A minimum service with a third wire safety ground to provide shock protection and avoid electromagnetic interference



### ***Risk of electric shock.***

The safety of this product requires connection to an outlet with a third-wire ground. Use only with three-prong power cord and outlet.

- The ICS power cord is 1.5 m (5 ft) long. You may connect the ICS to a power bar with a maximum length of 2 meters (6.5 ft), including power bar. The power bar must be approved by an appropriate National Test Body, with a third-wire ground. Do not use an extension cord between the ICS and the power bar, or between the power bar and the electrical outlet.

## Internal wiring requirements

### Norstar loop

- one, two or three twisted-pair cable(s) per telephone
- dc loop resistance of less than 64  $\Omega$
- cable length (0.5 mm or 24 AWG) less than 300 m (975 ft)
- use of a station auxiliary power supply (SAPS) for loops 300 m (975 ft) to 1200 m (3900 ft). The SAPS must be a Class 2 power source that is approved by an appropriate National Test Body.
- no bridge taps

### ISDN S reference point (S Loop)

- no longer than 1000 m (3,200 ft) for point to point
- no longer than 450 m (1,475 ft) on a point-to-multipoint extended passive bus
- no longer than 100 m (300 ft) for 75 ohm cable or 200 m (600 ft) for 150 ohm cable on a point-to-multipoint short passive bus

Wiring for the S reference point (S loop) should conform to ANSI T1.605. Wiring for the ISDN U reference point (U loop) should conform to ANSI T1.601.



#### ***Verify lightning protectors.***

Check the lightning protectors at the cable entry point to the building with special attention to the grounding. Report any problems to the telephone company, in writing.

Equipment that is designed to be connected using internal wiring is typically not lightning protected. Norstar telephone equipment and ISDN S loops and T loops should not leave the building where the ICS is installed.

# Spacing requirements

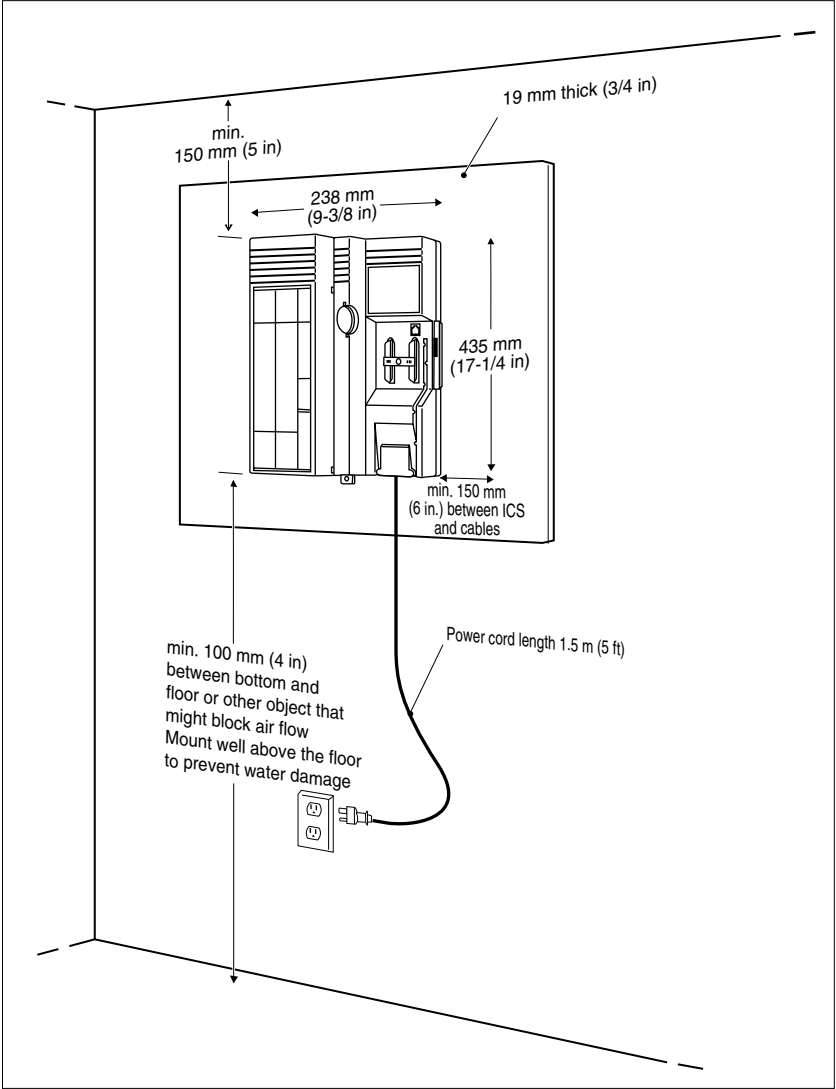



# Upgrading your system



## ***Only qualified persons should service the system.***

The installation and service of this unit is to be performed only by service personnel having appropriate training and experience necessary to be aware of hazards to which they are exposed in performing a task and of measures to minimize the danger to themselves or other persons.

Electrical shock hazards from the telecommunication network and AC mains are possible with this equipment. To minimize risk to service personnel and users, the ICS must be connected to an outlet with a third-wire ground. In addition, all unused slots must have filler faceplates installed and the system cover must be locked in place at the completion of any servicing.

Service personnel must be alert to the possibility of high leakage currents becoming available on metal system surfaces during power line fault events near network lines. Risk points on the ICS are the Feature Cartridge, heatsink and power cord earth ground pin. These leakage currents normally safely flow to Protective Earth ground via the power cord. Therefore, it is mandatory that connection to an earthed outlet is performed first and removed last when cabling to the unit. Specifically, operations requiring the unit to be powered down must have the network connections (central office lines) removed first.



## ***When upgrading, Call Log information will be lost.***

When the system restarts, Call Log information is not saved. Be sure to notify users if a system restart is planned so any log information can be written down first.

## Upgrading a restricted Feature Cartridge

You can upgrade your restricted feature cartridge by entering a series of Software Keys you obtain from Nortel Networks. This will add an additional eight ports for Norstar telephones. Refer *Software Keys* on page 242 for more information.

## Upgrading from 16 telephones to 24 telephones

The third slot in the ICS is used for an 8-port Expansion Cartridge, with or without clocking. Installing a Clocking Cartridge (no expansion) does not add additional Norstar telephone ports.

You cannot add the Expansion Cartridge to a system using a restricted feature cartridge that has not been upgraded.

1. Verify your system programming and update the *Programming Record*.
2. Disconnect all central office and station line connections from the ICS.
3. Remove power from your system.
4. Insert the Expansion Cartridge according to the Installation chapter.



### ***Risk of fire and electrical shock.***

For continued protection against risk of fire and electrical shock, ensure all unpopulated cartridge slots are covered by filler faceplates prior to powering up. Immediately after powering up, connect the central office and station line connectors and replace the cover.

5. Power up the system.
6. Connect the central office and station line connectors.
7. Replace the cover.



### ***Removing an Expansion Cartridge cold starts the system.***

If you remove the Expansion Cartridge or Expansion Cartridge with Clocking from the Compact ICS, you will lose all the system programming.

## Upgrading to Compact ICS 6.0

When you upgrade from Compact ICS 4.0 or 4.2 to 6.0:

- Lines 001 to 025 are renumbered to 001 to 030, and lines numbered 025 to 048 are renumbered to 031 to 060. Any peripheral devices that use these lines must be reprogrammed. Consequently, target lines have also been renumbered to 61-86.
  - The I-RAD password, found under Passwords in programming, resets to the default value.
1. Verify your system programming, and update the *Programming Record*.
  2. Disconnect all central office and station line connections from the ICS.
  3. Remove power from your system.
  4. Remove the Compact ICS 4.0 or 4.2 Feature Cartridge.
  5. Insert the Compact ICS 6.0 Feature Cartridge according to the Installation chapter.



### ***Risk of fire and electrical shock.***

For continued protection against risk of fire and electrical shock, ensure all unpopulated cartridge slots are covered by filler faceplates prior to powering up. Immediately after powering up, connect the central office and station line connectors and replace the cover.

6. Power up the system.
7. Connect the central office and station line connectors.
8. Replace the cover.

When you upgrade from Compact ICS 1.0 to 4.2:

Note: You cannot upgrade directly from pre-4.0 software to 6.0 software. You must do an interim upgrade to 4.X software.

- Lines 005-008 are renumbered as 025-028. Any peripheral devices that use these lines must be reprogrammed. These include voice mail or call accounting software, which use these lines.

- The I-RAD password, found under Passwords in programming, resets to the default value.
- If your programming uses a dialing string between 73-89 (for example, as destination codes), the programming is overwritten to create the DNs for ISDN terminal equipment.

You can upgrade directly from Compact ICS 2.0 to 4.2.



**Change DN length from two to three digits before upgrading.**

The Hunt groups feature requires at least three-digit DNs. If you expect to use Hunt groups, change the DN length to 3 before you carry out your other system programming. For more information see *Hunt groups* on page 194.

1. Verify your system programming, and update the *Programming Record*.
2. Disconnect all central office and station line connections from the ICS.
3. Remove power from your system.
4. Remove the Compact ICS 1.0 or 2.0 Feature Cartridge.
5. Insert the Compact ICS 4.X Feature Cartridge according to the Installation chapter.



**Risk of fire and electrical shock.**

For continued protection against risk of fire and electrical shock, ensure all unpopulated cartridge slots are covered by filler faceplates prior to powering up. Immediately after powering up, connect the central office and station line connectors and replace the cover.

6. Power up the system.
7. Connect the central office and station line connectors.
8. Replace the cover.



**Note:** If you want to upgrade from a configuration that does not support programmable prompts for the Auto Attendant, to one that does have programmable prompts, you will have to obtain the *Compact ICS 6.0 standard software, I-RAD enabled, Auto Attendant with programmable prompts* configuration.

## Upgrading Expansion Cartridge for BRI Card installation

The ICS must be equipped with an Expansion Cartridge with Clocking or a Clocking Cartridge to support BRI Cards.

The Expansion Cartridge with Clocking adds eight Norstar telephone ports in addition to clocking.

1. Disconnect all central office and station line connections from the ICS.
2. Remove power from your system.
3. Remove the Expansion Cartridge (without clocking).
4. Insert the Expansion Cartridge (with clocking) according to the Installation chapter.



### ***Risk of fire and electrical shock.***

For continued protection against risk of fire and electrical shock, ensure all unpopulated cartridge slots are covered by filler faceplates prior to powering up. Immediately after powering up, connect the central office and station line connectors and replace the cover.

5. Power up the system.
6. Connect the central office and station line connectors.
7. Replace the cover.





***Only qualified persons should service the system.***

The installation and service of this unit is to be performed only by service personnel having appropriate training and experience necessary to be aware of hazards to which they are exposed in performing a task and of measures to minimize the danger to themselves or other persons.

Electrical shock hazards from the telecommunication network and AC mains are possible with this equipment. To minimize risk to service personnel and users, the ICS must be connected to an outlet with a third-wire ground. In addition, all unused slots must have filler faceplates installed and the system cover must be locked in place at the completion of any servicing.

Service personnel must be alert to the possibility of high leakage currents becoming available on metal system surfaces during power line fault events near network lines. Risk points on the ICS are the Feature Cartridge, heatsink and power cord earth ground pin. These leakage currents normally safely flow to Protective Earth ground via the power cord.

Therefore, it is mandatory that connection to an earthed outlet is performed first and removed last when cabling to the unit. Specifically, operations requiring the unit to be powered down must have the network connections (central office lines) removed first.

## Installation checklist

- test all ISDN network connections, if any
- mount the Integrated Communications System (ICS)
- install the Feature Cartridge
- install the Trunk Cartridge and BRI Cards (as required)
- install the appropriate expansion or clocking cartridge

Note: You must use the Expansion Cartridge with Clocking or Clocking Cartridge to support BRI Cards)

- complete the wiring, but do not connect the central office and station line connectors
- install filler faceplates (slot covers)
- install the emergency telephone(s), if required
- install the Norstar telephones
- install ISDN terminal equipment (TE)
- install the other optional equipment
- install the analog telephone(s)
- power up the system
- connect the central office and station line connectors
- install the cover

**Avoid electrical shock.**

To avoid electrical shock hazard to personnel, or equipment damage, observe the following precautions when installing telephone equipment:

Always disconnect telecommunication network connections before disconnecting the AC power plug.

Never connect the central office and station line connectors until you have connected the power plug.

Never install telephone wiring during a lightning storm.

Never install telephone jacks in wet locations unless the jack is specifically designed for wet locations.

Never touch non-insulated telephone wires or terminals unless the telephone line has been disconnected at the network interface.

Use caution when modifying or installing telephone lines.

**Do not fasten power supply cords.**

To comply with UL1459, do not fasten the ICS power supply cord to any building surface, including the backboard.

# Testing the ISDN network connection

---

Before you install a Norstar system which uses BRI Cards, you should test your connection to the ISDN network.

If you are installing a system which connects to the network using BRI-ST Cards, the network connection must be equipped with an NT1. See the ISDN chapter and the wiring information in this chapter for more information about installing an NT1.

To test the ISDN connection:

1. Connect ISDN terminal equipment (TE) that conforms to Bellcore standards to your central office ISDN jack or NT1. U interface TE can connect directly to the central office jack; S interface TE connect to the central office through an NT1.
2. Program the TE with the appropriate switch type, service profile identifier (SPID), and Network directory number (DN) using the instructions that come with the TE.
3. Check for dial tone, then place a call and verify the quality and clarity of the connection. If there is a problem, contact your service provider.
4. Repeat steps one through three for each network connection.

# Mounting the ICS

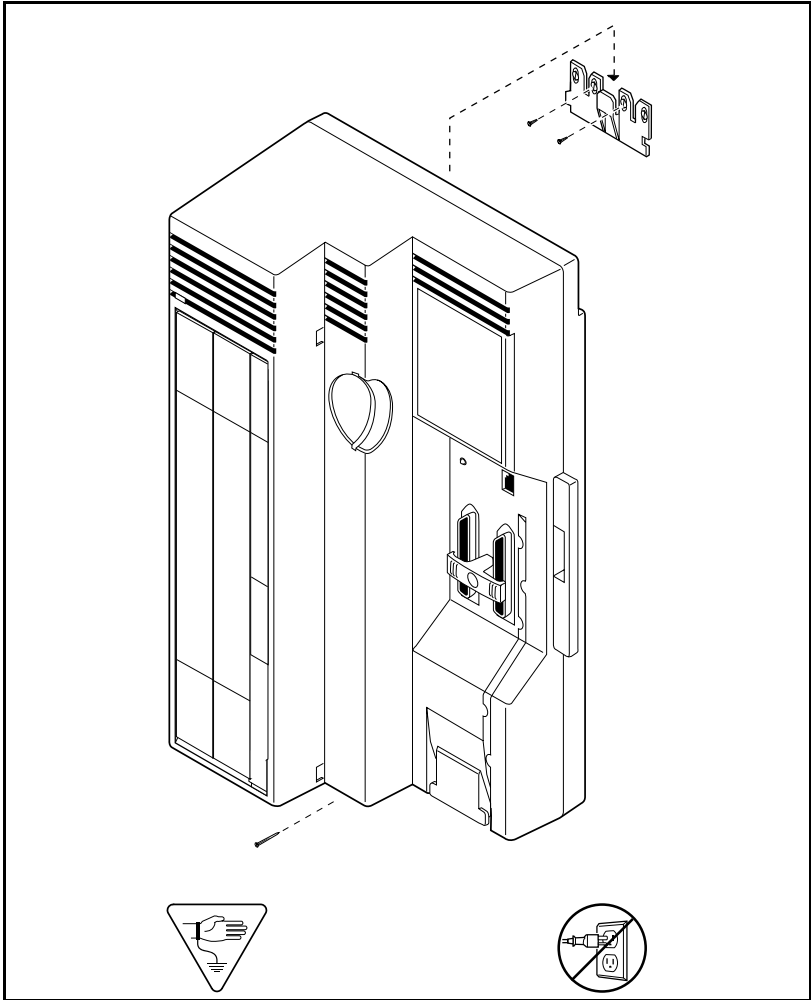

## ***Attach bracket to secure surface.***

Screw the ICS mounting bracket and ICS to a 19mm wood backboard secured to a wall and capable of supporting a 20 kg (44 lbs) mass. Do not screw bracket directly to drywall. Use the two inner screw holes on the bracket.

# Installing the cartridges

The following table shows which cartridges can be installed in the ICS slots.

Cartridge type	ICS slot
CICS 6.0 Restricted software (4 X 8)	Feature Cartridge Slot
CICS 6.0 Standard software (16 X 24)	Feature Cartridge Slot
CICS 6.0 Restricted software (I-RAD enabled)	Feature Cartridge Slot
CICS 6.0 Standard software (I-RAD enabled)	Feature Cartridge Slot
CICS 6.0 Standard software (I-RAD enabled) Auto Attendant with programmable prompts	Feature Cartridge Slot
Expansion Cartridge (8 ports)	3
Expansion Cartridge (8 ports) with Clocking	3
Clocking Cartridge	3
Global Analog Trunk Cartridge (GATC) with LS/DS replaces Loop Start/Disconnect Supervision (LS/DS) Analog Trunk Cartridge (supported on existing systems, only)	1 or 2
Global Analog Trunk Cartridge (GATC) with CLID replaces Caller Identification (CI) Trunk Cartridge (supported on existing systems, only)	1 or 2
BRI-ST Card	1 or 2
BRI-U2 Card	1 or 2
BRI-U4 Card	1 or 2

**GATC with LS/DS and GATC with CLID ( LS/DS Analog Trunk Cartridges and Caller Identification) Trunk Cartridges support loop start external lines.**



A system equipped with a restricted feature cartridge supports only the BRI-U2 Card. It cannot support BRI-U4 or BRI-ST Cards.



***PCB is electrostatic-sensitive.***

Do not touch the printed circuit board on a cartridge. This is an electrostatic-sensitive device.



***Close clips simultaneously.***

It is important to center and close the two clips on the cartridge simultaneously, or the cartridge may become misaligned in its slot, or with its connector.

## ICS slots and connectors

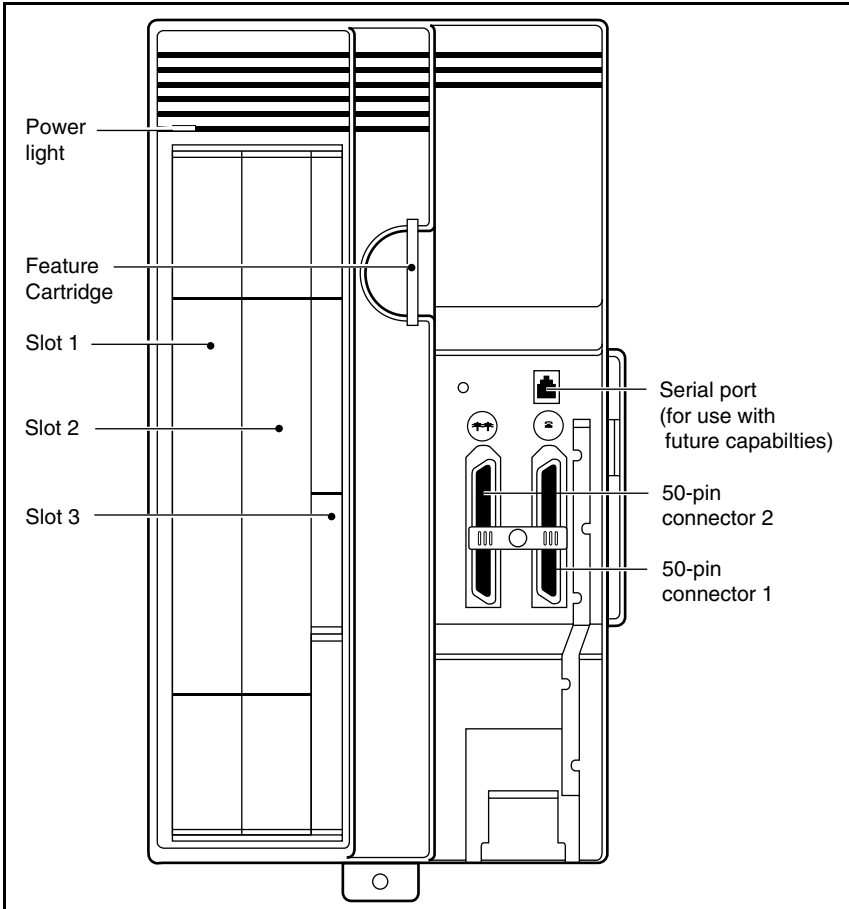

## Removing the cover

To remove the cover, insert a screwdriver at the tab on the right side of the ICS. Pry the latch open.

## Installing the Feature Cartridge

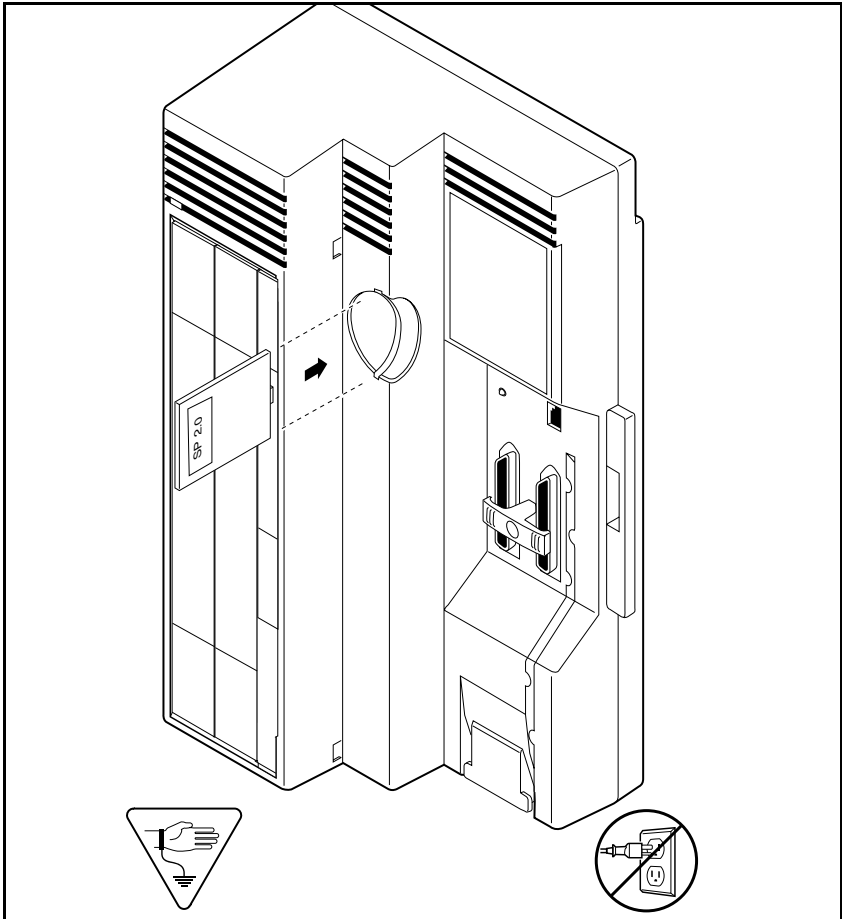

### ***Insert Feature Cartridge one way.***

To ensure the connector is properly installed, insert the Feature Cartridge so that the connector is properly aligned in the interior slot and the version label is visible after installation.

## Terminating resistors on BRI-ST Cards

The standard ISDN user-network interface wiring requires terminating resistors at each end of the loop for both point-to-point and point-to-multipoint operation. This ensures correct timing of the signaling circuits.

Loop termination can be provided at either the point where the ISDN terminal is attached, or by the device attached to the loop (with built-in termination).

Because the Compact ICS is usually at the one end of the loop, the BRI-ST Card is shipped with built-in termination for each ISDN loop. It is ready to be used where the ICS is located at one end of the loop, as shown in the following illustration:

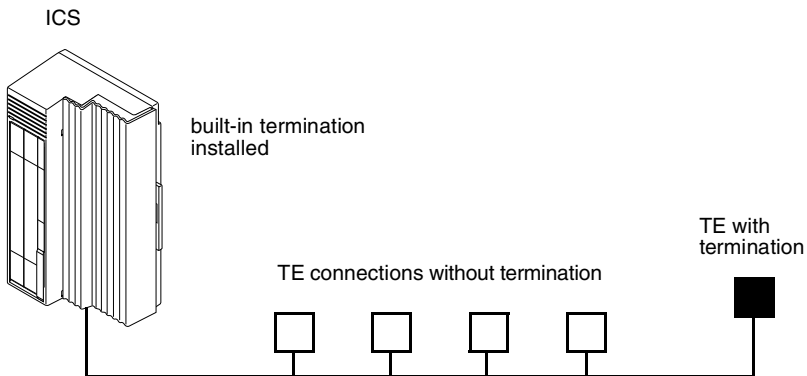

## Shorting straps on a BRI-ST Card

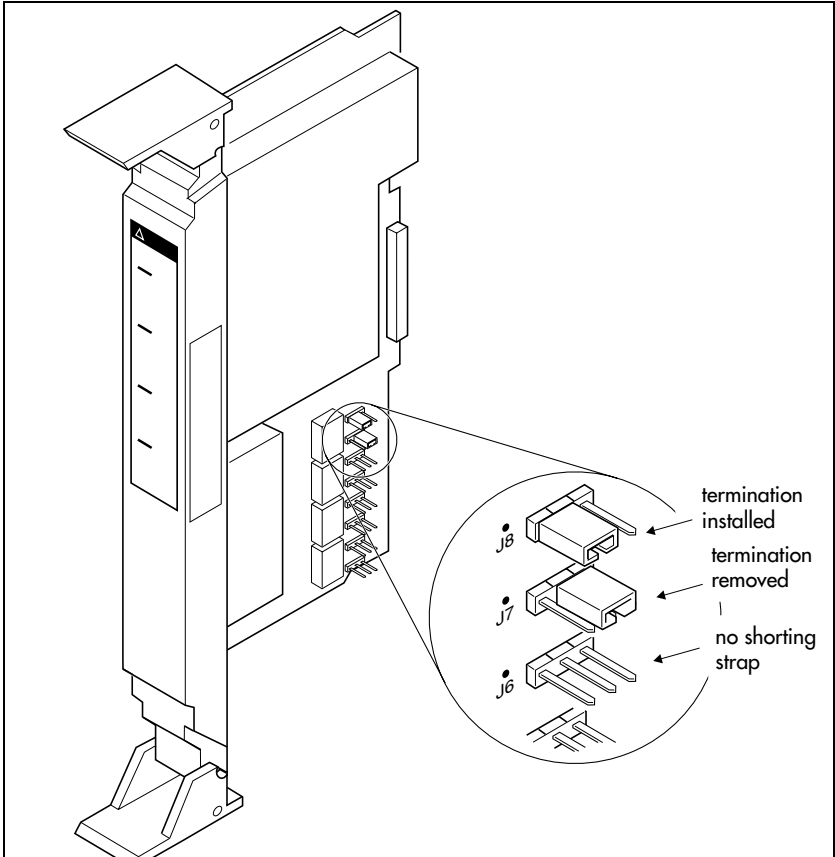

Make sure the shorting straps are installed on both the receive and transmit jumpers for the loop (see illustration). The jumpers are numbered top to bottom, but the loops associated with each pair of jumpers does not follow the same top-to-bottom sequence (see table below).

Loop	RX and TX shorting straps
1	J3 and J4
2	J7 and J8
3	J1 and J2
4	J5 and J6

## Installing Trunk Cartridges

1. Slide the Trunk Cartridge into slot 1, applying equal pressure at the top and bottom. See illustration on the next page.
2. Close the cartridge clips at the same time, to keep the cartridge aligned with the connector.
3. If you are installing a second trunk cartridge, remove the filler faceplate from slot 2 and slot 3 (it is one piece), using a screwdriver at the bottom of each slot and prying the bottom edge out.
4. Snap the two parts of the faceplate apart and put back the filler faceplate in slot 3.
5. Insert the second Trunk Cartridge, as described in steps 2 and 3.

## Global Analog Trunk Cartridge/CLI Cartridge

These cartridges have dip switches that may need to be set if your system is not running with the North American profile (Profile 1). Set the dip switches before you install the cartridge.

### GATC dip switch settings (default is North America)(



The following table lists the various dip switch settings. However, for this release, only the North America, Taiwan, and Australia settings are active.

DIP switch setting	Country profile
00000000	North America
10000000	Taiwan
01000000	Australia
11000000	*Chili
00100000	*Peru

DIP switch setting	Country profile
10100000	*Argentina
01100000	*Mexico
11100000	*Sweden
00010000	*South America
10010000	*Brazil
01010000	*Norway
11010000	*France
00110000	*Germany
10110000	*Korea
XXXXXXXX1	*Reserved
XXXXXXXX1X	*Reserved
XXXXXX1XX	*Reserved
* Reserved for future development	

## Off-core DTI card

MICS 6.0 provides the opportunity to expand the number of DTI cards in your system by adding a DTI card to the expansion modules in a midi or maxi system. The card must be installed in either module 3 or 4 on a midi system. On the maxi system, the card can only be installed in module 7 or 8. One DTI card requires the entire module resources, so the other two slots must be left empty. Otherwise, the off-core DTI is configured in the same way as the other DTIs on your system.

This card is supported for profiles 1, 3 and 4.

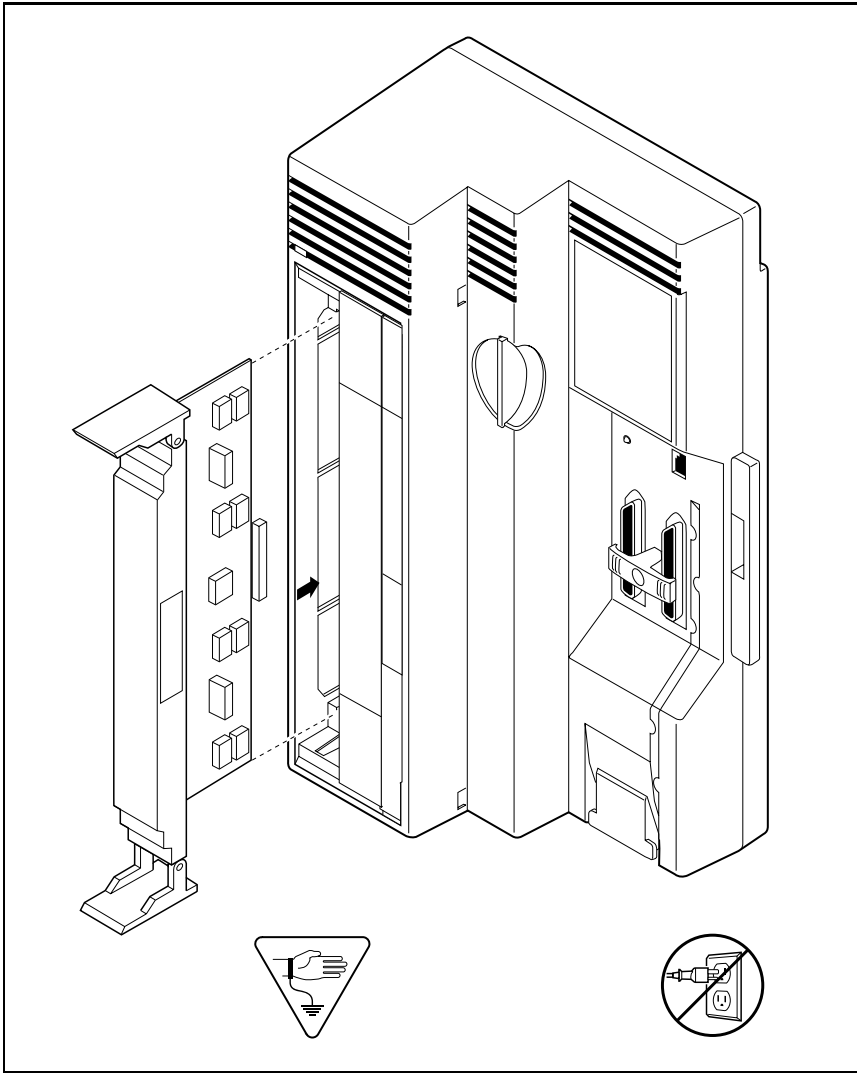



## Installing the Expansion Cartridge

The Expansion Cartridge must be equipped with clock control if you are installing BRI Cards.

1. Remove the filler faceplate from slot 3 (and slot 2 if there is no Trunk Cartridge), using a screwdriver to pry the bottom edge(s) out.
2. If required, snap the two parts of the faceplate apart and put back the filler faceplate in slot 2.
3. Slide the Expansion Cartridge into slot 3, applying equal pressure at the top and bottom. See illustration on page 82.
4. Close the cartridge clips at the same time, to keep the cartridge aligned with the connector.

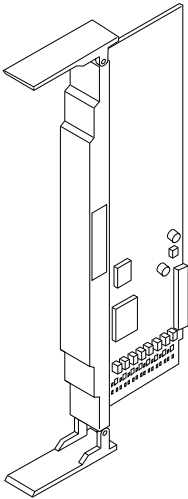

Expansion Cartridge

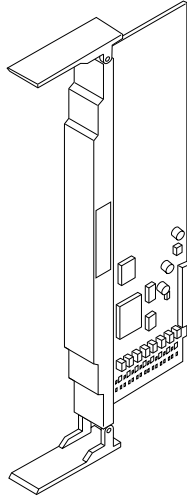

Expansion Cartridge  
with Clocking

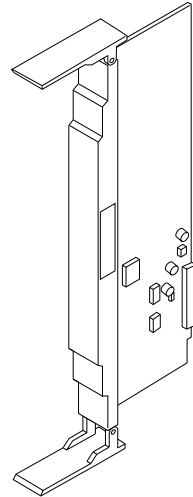

Clocking Cartridge



***Removing the expansion cartridge will cause a cold restart.***

If you downsize the system by removing the expansion cartridge, all system programming will be lost.



***Alarm Telephone will indicate a cold reset.***

An alarm and a prompt indicating warm or cold reset will occur on the alarm telephone when the system size has been decreased.

**Installing the Expansion Cartridge**

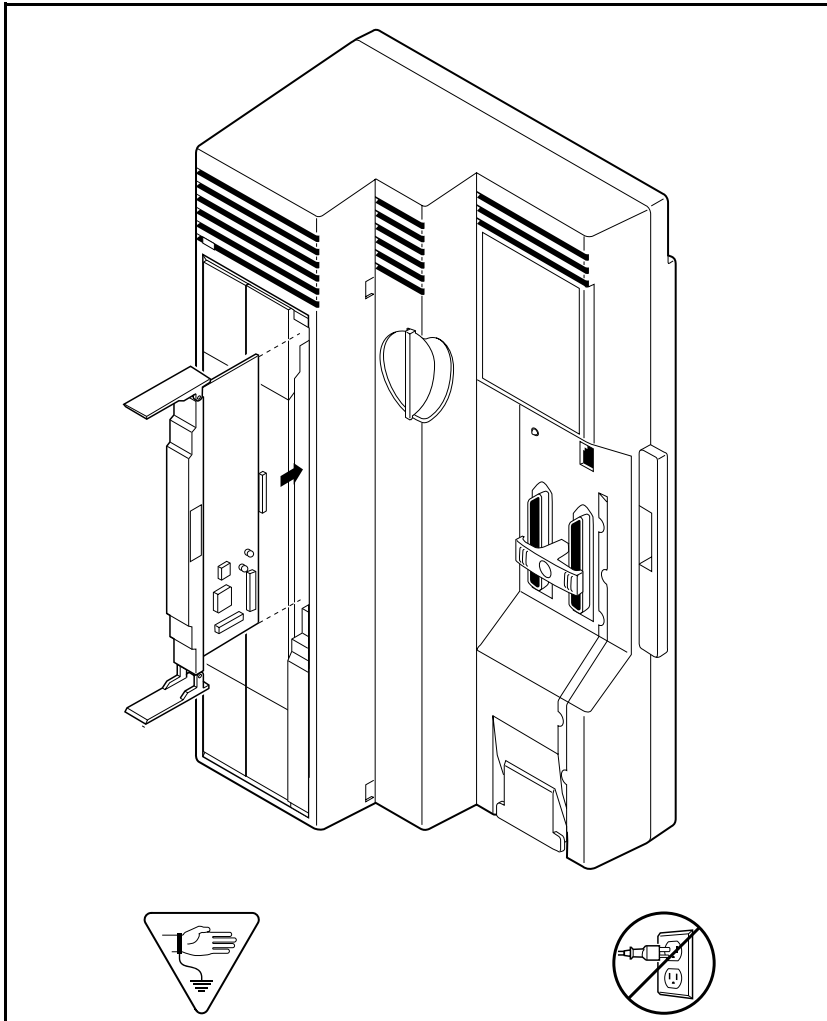

# Connecting the wiring

## Connecting the wiring for a Compact ICS

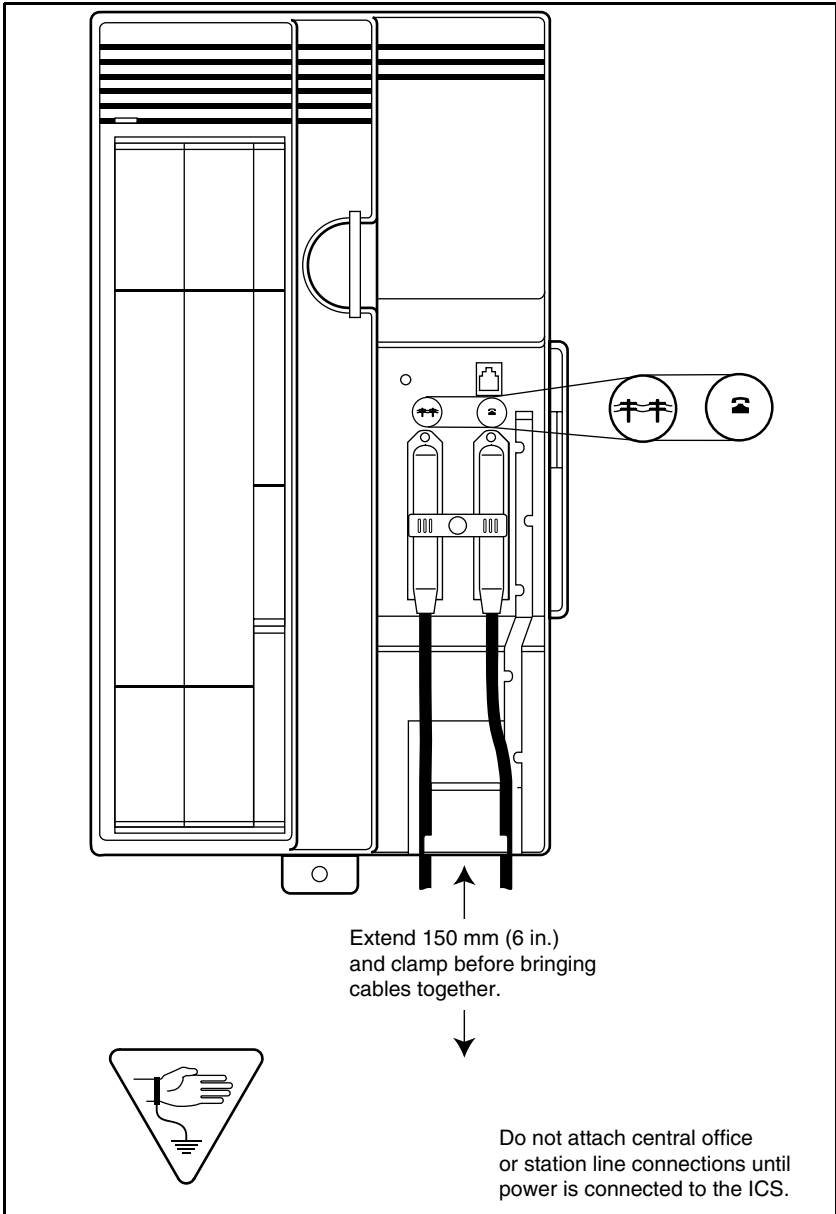

## Connecting the wiring to the distribution panel

1. Route the cables from the ICS to the distribution panel.
2. Bundle the cables with cable ties and secure them to the wall to support their weight.
3. Connect the telephone and auxiliary equipment wires to the appropriate pins on the distribution block (refer to the wiring charts).
4. Cross-connect the ICS telephone and auxiliary equipment wiring to the corresponding station pins on the distribution block.
5. Using a single pair of wires for each telephone, connect each of the telephones according to the wiring charts.
6. Cross-connect the external lines to the distribution block (refer to the wiring charts).

## Wiring charts

### Port numbering on the wiring charts

The port number listed on the wiring charts is useful in tracking down faults during a Maintenance session where error codes appear on a Norstar telephone display. Refer to *Maintenance* on page 291 for more information.

For example, the code 112 appearing as part of an error message indicates that the problem is with the telephone connected to the system at port 112. The corresponding pins on the distribution block are pin 37 (black-orange) and pin 12 (orange-black).

### Integrated Communications System (ICS)

In the charts on the following pages, notice that the ICS has two 25-pair connectors. One handles telephones and auxiliary ringer. The other handles lines, I-ATA, music, and page.

## B1 and B2 directory numbers (DNs)

Norstar has a B1 and B2 channel for transmitting voice and data. Each telephone port on the ICS has a B1 DN and a B2 DN. Devices such as the Business Series Terminals, and Norstar telephones use only the B1 DN. Other devices may need both B1 and B2 channels, therefore requiring B1 and B2 DNs.

Norstar Compact ICS uses different numbering schemes for the B1 and B2 DNs, depending on how you upgrade your system and when an Expansion Cartridge is added. See the tables below for details.

### ICS numbering (restricted feature cartridge)

Connector #	Device	Ports	B1 DN	B2 DN
ICS (#1)	Telephones 1-8	101-108	21-28	31-38
	I-ATA	117	29 (I-ATA)	39
	I-RAD	118	30 (I-RAD)	40
ICS (#2)	Lines 001-004	201-204	— —	— —

### ICS numbering (restricted feature cartridge, expanded)

Connector #	Device	Ports	B1 DN	B2 DN
ICS (#1)	Telephones 1-8	101-108	21-28	31-38
	I-ATA	117	29 (I-ATA)	39
	I-RAD	118	30 (I-RAD)	40
	Telephones 9-16	109-116	41-48	49-56
ICS (#2)	Analog:			
	Lines 001-004	201-204	— —	— —
	Lines 031-034	231-234	— —	— —
	BRI:			
	Lines 001-008	201-208	— —	— —
	Lines 031-038	231-238	— —	— —

**ICS numbering (restricted feature cartridge, expanded):  
Expansion Cartridge added**

<b>Connector #</b>	<b>Device</b>	<b>Ports</b>	<b>B1 DN</b>	<b>B2 DN</b>
ICS (#1)	Telephones 1-8	101-108	21-28	31-38
	I-ATA	117	29 (I-ATA)	39
	I-RAD	118	30 (I-RAD)	40
	Telephones 9-16	109-116	41-48	49-56
	Telephones 17-24	119-126	57-64	65-72
ICS (#2)	Analog: Lines 001-004	201-204	---	---
	Lines 031-034	231-234	---	---
	BRI: Lines 001-008	201-208	---	---
	Lines 031-038	231-238	---	---

**ICS numbering (standard feature cartridge)**

<b>Connector #</b>	<b>Device</b>	<b>Ports</b>	<b>B1 DN</b>	<b>B2 DN</b>
ICS (#1)	Telephones 1-16	101-116	21-36	39-54
	I-ATA	117	37 (I-ATA)	55
	I-RAD	118	38 (I-RAD)	56
ICS (#2)	Analog: Lines 001-004	201-204	---	---
	Lines 031-034	231-234	---	---
	BRI: Lines 001-008	201-208	---	---
	Lines 031-038	231-238	---	---

**ICS numbering (standard feature cartridge): Expansion  
Cartridge added at installation**

<b>Connector #</b>	<b>Device</b>	<b>Ports</b>	<b>B1 DN</b>	<b>B2 DN</b>
ICS (#1)	Telephones 1-16	101-116	21-36	47-62
	I-ATA	117	37 (I-ATA)	63
	I-RAD	118	38 (I-RAD)	64
	Telephones 17-24	119-126	39-46	65-72

ICS (#2)	Analog:			
	Lines 001-004	201-204	---	---
	Lines 031-034	231-234	---	---
	BRI:			
	Lines 001-008	201-208	---	---
	Lines 031-038	231-238	---	---

**ICS numbering (standard feature cartridge): Expansion Cartridge added later**

Connector #	Device	Ports	B1 DN	B2 DN
ICS (#1)	Telephones 1-16	101-116	21-36	39-54
	I-ATA	117	37 (I-ATA)	55
	I-RAD	118	38 (I-RAD)	56
	Telephones 17-24	119-126	57-64	65-72
ICS (#2)	Analog:			
	Lines 001-004	201-204	---	---
	Lines 031-034	231-234	---	---
	BRI:			
	Lines 001-008	201-208	---	---
	Lines 031-038	231-238	---	---



**Tip** - B1 and B2 directory numbers reflect the default numbering scheme.



***I-ATA and I-RAD are not physically connected to the ICS #1 25-pair connector.***

The internal analog terminal adaptor (I-ATA) is wired on the ICS #2 connector along with the external lines and equipment for music and paging. The internal remote access device (I-RAD) appears on port 118 but has no wired connection.

---

**ICS telephone and auxiliary ringer wiring chart**

---

<b>Pin</b>	<b>Wire color</b>	<b>Port</b>	<b>Service</b>	<b>Telephones (ICS)</b>
26	White-Blue	101	T	1
1	Blue-White	101	R	1
27	White-Orange	102	T	2
2	Orange-White	102	R	2
28	White-Green	103	T	3
3	Green-White	103	R	3
29	White-Brown	104	T	4
4	Brown-White	104	R	4
30	White-Slate	105	T	5
5	Slate-White	105	R	5
31	Red-Blue	106	T	6
6	Blue-Red	106	R	6
32	Red-Orange	107	T	7
7	Orange-Red	107	R	7
33	Red-Green	108	T	8
8	Green-Red	108	R	8
34	Red-Brown	109	T	9
9	Brown-Red	109	R	9
35	Red-Slate	110	T	10
10	Slate-Red	110	R	10
36	Black-Blue	111	T	11
11	Blue-Black	111	R	11
37	Black-Orange	112	T	12
12	Orange-Black	112	R	12
38	Black-Green	113	T	13
13	Green-Black	113	R	13
39	Black-Brown	114	T	14
14	Brown-Black	114	R	14
40	Black-Slate	115	T	15
15	Slate-Black	115	R	15
41	Yellow-Blue	116	T	16



<b>Pin</b>	<b>Wire color</b>	<b>Port</b>	<b>Service</b>	<b>Telephones (ICS)</b>
16	Blue-Yellow	116	R	16
no physical connection at port 117 (reserved for I-ATA)				
no physical connection at port 118 (reserved for I-RAD)				
42	Yellow-Orange	119	T	17
17	Orange-Yellow	119	R	17
43	Yellow-Green	120	T	18
18	Green-Yellow	120	R	18
44	Yellow-Brown	121	T	19
19	Brown-Yellow	121	R	19
45	Yellow-Slate	122	T	20
20	Slate-Yellow	122	R	20
46	Violet-Blue	123	T	21
21	Blue-Violet	123	R	21
47	Violet-Orange	124	T	22
22	Orange-Violet	124	R	22
48	Violet-Green	125	T	23
23	Green-Violet	125	R	23
49	Violet-Brown	126	T	24
24	Brown-Violet	126	R	24
50	Violet-Slate	----	Make	Aux. ringer
25	Slate-Violet	----	Common	Aux. ringer

T and R represent station connections and should not be confused with Tip and Ring on external lines. Station connections are non-polarized.

Stations 18 through 25 are available only when an Expansion Cartridge is installed.

For default DNs, see the ICS numbering charts starting on page 85.

### Wiring arrangement for Norstar ICS

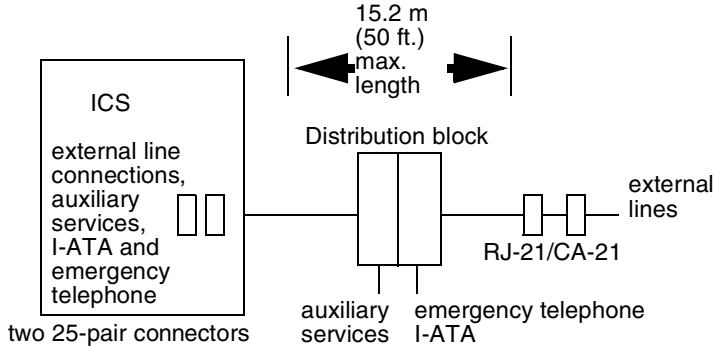

### ICS external lines, I-ATA, music, and page wiring

#### ICS external lines connector

Pin	Wire color	Port	Service	Equipment
26	White-Blue	201	T	Line 1
1	Blue-White	201	R	Line 1
27	White-Orange	202	T	Line 2
2	Orange-White	202	R	Line 2
28	White-Green	----	----	----
3	Green-White	----	----	----
29	White-Brown	----	----	----
4	Brown-White	----	----	----
30	White-Slate	203	T	Line 3
5	Slate-White	203	R	Line 3
31	Red-Blue	204	T	Line 4
6	Blue-Red	204	R	Line 4
32	Red-Orange	----	----	----
7	Orange-Red	----	----	----
33	Red-Green	----	----	----
8	Green-Red	----	----	----
34	Red-Brown	231	T	Line 31
9	Brown-Red	231	R	Line 31

<b>ICS external lines connector</b>				
<b>Pin</b>	<b>Wire color</b>	<b>Port</b>	<b>Service</b>	<b>Equipment</b>
35	Red-Slate	232	T	Line 32
10	Slate-Red	232	R	Line 32
36	Black-Blue	----	----	----
11	Blue-Black	----	----	----
37	Black-Orange	----	----	----
12	Orange-Black	----	----	----
38	Black-Green	233	T	Line 33
13	Green-Black	233	R	Line 33
39	Black-Brown	234	T	Line 34
14	Brown-Black	234	R	Line 34
40	Black-Slate	----	----	----
15	Slate-Black	----	----	----
41	Yellow-Blue	----	----	----
16	Blue-Yellow	----	----	----
42	Yellow-Orange	----	T	emergency telephone
17	Orange-Yellow	----	R	emergency telephone
43	Yellow-Green	----	----	----
18	Green-Yellow	----	----	----
44	Yellow-Brown	----	----	----
19	Brown-Yellow	----	----	----
45	Yellow-Slate	117	T	I-ATA
20	Slate-Yellow	117	R	I-ATA
46	Violet-Blue	----	----	----
21	Blue-Violet	----	----	----
47	Violet-Orange	----	----	----
22	Orange-Violet	----	----	----
48	Violet-Green	----	Ground	Music
23	Green-Violet	----	Music	Music
49	Violet-Brown	----	Make	External Page
24	Brown-Violet	----	Common	External Page

**ICS external lines connector**

Pin	Wire color	Port	Service	Equipment
50	Violet-Slate	----	T	Page
25	Slate-Violet	----	R	Page

Lines 5 through 8 are not available to a system using a restricted feature cartridge that has not been upgraded. For an explanation of port numbering, see *Port numbering on the wiring charts* on page 84. The emergency telephone uses line 002 (on Trunk Cartridge in slot 1).

***Music source must be grounded.***

To avoid possible damage to your Compact ICS system or music source, the music source ground must be connected according to the wiring charts.

**BRI Wiring charts**

A BRI Card in Slot 1 uses loops 201 through 204. A BRI Card in Slot 2 uses loops 231 through 234. Because a BRI-U2 Card has only two loops, it only uses the first two loop numbers (201-202 and 231-232) when it occupies an ICS slot.

The loops appearing on a BRI Card may be automatically assigned lines, or assigned one or more ISDN DNs in Hardware programming. If the loop is configured as S or T or NT, lines are automatically assigned. If the loop is configured as S or LT, you can assign one or more ISDN DNs to the loop.

The emergency telephone connection (pins 42 and 17 on ICS #2 connector) cannot be used if a BRI Card is installed in Slot 1. All other pins which are not shown in the BRI wiring charts are assigned as shown in the non-BRI wiring charts beginning on page 88.

Detailed information about configuring BRI Cards is included in the ISDN chapter and in the Hardware section of the Programming chapter.

## ST Interface Cards wiring chart

Pin	Wire color	Loop	Service	Lines (S or T loop)	Terminal equipment (S loop)
26	White-Blue	201	+Tx	Lines 001-002	Assigned DN
1	Blue-White	201	-Tx	Lines 001-002	Assigned DN
27	White-Orange	201	+Rx	Lines 001-002	Assigned DN
2	Orange-White	201	-Rx	Lines 001-002	Assigned DN
28	White-Green	202	+Tx	Lines 003-004	Assigned DN
3	Green-White	202	-Tx	Lines 003-004	Assigned DN
29	White-Brown	202	+Rx	Lines 003-004	Assigned DN
4	Brown-White	202	-Rx	Lines 003-004	Assigned DN
30	White-Slate	203	+Tx	Lines 005-006	Assigned DN
5	Slate-White	203	-Tx	Lines 005-006	Assigned DN
31	Red-Blue	203	+Rx	Lines 005-006	Assigned DN
6	Blue-Red	203	-Rx	Lines 005-006	Assigned DN
32	Red-Orange	204	+Tx	Lines 007-008	Assigned DN
7	Orange-Red	204	-Tx	Lines 007-008	Assigned DN
33	Red-Green	204	+Rx	Lines 007-008	Assigned DN
8	Green-Red	204	-Rx	Lines 007-008	Assigned DN
34	Red-Brown	231	+Tx	Lines 031-032	Assigned DN
9	Brown-Red	231	-Tx	Lines 031-032	Assigned DN
35	Red-Slate	231	+Rx	Lines 031-032	Assigned DN
10	Slate-Red	231	-Rx	Lines 031-032	Assigned DN
36	Black-Blue	232	+Tx	Lines 033-034	Assigned DN
11	Blue-Black	232	-Tx	Lines 033-034	Assigned DN
37	Black-Orange	232	+Rx	Lines 033-034	Assigned DN
12	Orange-Black	232	-Rx	Lines 033-034	Assigned DN
38	Black-Green	233	+Tx	Lines 035-036	Assigned DN
13	Green-Black	233	-Tx	Lines 035-036	Assigned DN
39	Black-Brown	233	+Rx	Lines 035-036	Assigned DN
14	Brown-Black	233	-Rx	Lines 035-036	Assigned DN
40	Black-Slate	234	+Tx	Lines 037-038	Assigned DN
15	Slate-Black	234	-Tx	Lines 037-038	Assigned DN

Pin	Wire color	Loop	Service	Lines (S or T loop)	Terminal equipment (S loop)
41	Yellow-Blue	234	+Rx	Lines 037-038	Assigned DN
16	Blue-Yellow	234	-Rx	Lines 037-038	Assigned DN

BRI ST wiring is polarity sensitive.

Tx and Rx are Transmit and Receive for Norstar.

### U Interface Cards wiring chart

Pin	Wire color	Loop	Service	Lines (U-NT)	Terminal equipment (U-LT)
26	White-Blue	201	T	Lines 001-002	Assigned DN
1	Blue-White	201	R	Lines 001-002	Assigned DN
27	White-Orange	202	T	Lines 003-004	Assigned DN
2	Orange-White	202	R	Lines 003-004	Assigned DN
28	White-Green	----	----	----	----
3	Green-White	----	----	----	----
29	White-Brown	----	----	----	----
4	Brown-White	----	----	----	----
30	White-Slate	203	T	Lines 005-006	Assigned DN
5	Slate-White	203	R	Lines 005-006	Assigned DN
31	Red-Blue	204	T	Lines 007-008	Assigned DN
6	Blue-Red	204	R	Lines 007-008	Assigned DN
32	Red-Orange	----	----	----	----
7	Orange-Red	----	----	----	----
33	Red-Green	----	----	----	----
8	Green-Red	----	----	----	----
34	Red-Brown	231	T	Lines 031-032	Assigned DN
9	Brown-Red	231	R	Lines 031-032	Assigned DN
35	Red-Slate	232	T	Lines 033-034	Assigned DN
10	Slate-Red	232	R	Lines 033-034	Assigned DN
36	Black-Blue	----	----	----	----
11	Blue-Black	----	----	----	----

37	Black-Orange	----	----	----	----
12	Orange-Black	----	----	----	----
38	Black-Green	233	T	Lines 035-036	Assigned DN
13	Green-Black	233	R	Lines 035-036	Assigned DN
39	Black-Brown	234	T	Lines 037-038	Assigned DN
14	Brown-Black	234	R	Lines 037-038	Assigned DN
40	Black-Slate	----	----	----	----
15	Slate-Black	----	----	----	----
41	Yellow-Blue	----	----	----	----
16	Blue-Yellow	----	----	----	----

BRI U wiring is not polarity sensitive.

## Wiring the BRI network interface

A network interface provides the connection between the ISDN network and the Compact ICS.

If the card in the ICS is configured as a T loop, the ICS is wired to the network connection using an NT1. For an S or T loop, the ICS and terminal equipment share the loop wired to the NT1, which is in turn wired to the network. See the ISDN chapter for more information about the NT1.

### Wiring for T or S network connection

Pin (jack or plug)	NT1 connection (for jack)	ICS and optional TE connection (plug)
1	not used	optional power source 3 (+)
2	not used	optional power source 3 (-)
3	+Rx	+Tx
4	+Tx	+Rx
5	-Tx	-Rx
6	-Rx	-Tx
7	not used	optional power sink 2 (-)
8	not used	optional power sink 2 (+)

The Compact ICS supplies the NT1 functionality to a U-NT loop, allowing a direct connection to the network. The connection may use a plug and jack, or may be directly wired.

### Wiring for U-NT network interface

Pin	Norstar connection	Network interface connection (plug/jack)
1	not used	optional battery status indicator (+)
2	not used	optional battery status indicator (-)
3	not used	no connection
4	R	R
5	T	T
6	not used	no connection
7	not used	optional power supply (-)
8	not used	optional power supply (+)

The BRI-U Card does not use or provide optional power. Some installations may not use a plug and jack for connections between the ICS and the network.

The following illustration shows the pin arrangement for a Bellcore standard ISDN plug and jack. Other pin arrangements are possible.

### Pin numbering for network interface jack and plug

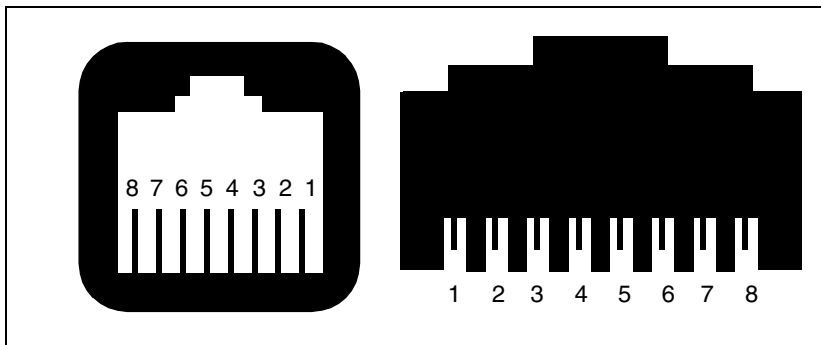



## Wiring arrangement for serial port

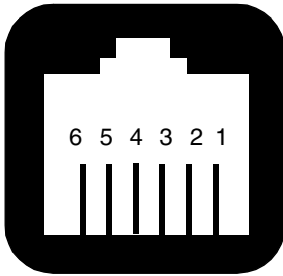

1 = TxEN (input)

2 = signal GND

3 = TxD (output)

4 = RxD (input)

5 = ----

6 = RxRDY (output)

---

# Installing Norstar telephones

---

## Installing the emergency telephone

You can connect an analog emergency telephone to an ICS with a Loop Start Trunk Cartridge to provide emergency service when there is no power to the ICS. Install and test the telephone before powering up your system.

1. Wire a modular jack or equivalent to the emergency telephone pins on the 25-pair distribution block for the ICS external lines. (See the wiring charts for the pin numbers.)
2. Connect an analog telephone (500/2500) to the modular jack.
3. Prepare to test the emergency telephone by removing the Trunk Cartridge from the left slot.
4. Connect the power, then connect the central office lines to the ICS.
5. Pick up the emergency telephone handset and listen for dial tone.
6. Disconnect the central office lines, then remove power from the system.
7. Replace the Trunk Cartridge in the left slot.
8. Continue with procedures for powering up the system.
9. The emergency telephone uses line 002.



**Tip** - *When a BRI-ST or BRI-U Card is installed in the left-most Trunk Cartridge slot (Slot 1), you cannot use an analog emergency telephone.*

*During a power outage, an ISDN terminal sharing an S or T multi-point bus with the Compact ICS may provide telephone service.*

## Installing the device that uses the I-ATA

You can connect an analog telecommunications device such as a fax machine, answering machine, modem, or single-line telephone to the internal analog terminal adapter (I-ATA).

1. Wire a modular jack or equivalent to the I-ATA pins on the 25-pair distribution block for the ICS external lines and I-ATA. (See the wiring charts for the pin numbers).
2. Connect the analog device to the modular jack.
3. After the system has been powered up, verify proper operation. Refer to testing instructions in *Problems with the I-ATA* on page 268.

The I-ATA cannot be used as an off-premise extension (OPX). Maximum loop length is 900 m (3000 ft.).

The I-ATA provides a reduced power analog interface for on-premises devices. See the specifications on page 329 for detailed electrical specifications.



**Tip** - *If you are currently using an ATA to connect a modem to the Compact ICS, and your system has access to a BRI network, you can now use a digital trunk supplied by a BRI Card for modem calls to improve the transmission quality.*

## Installing Business Series Terminals

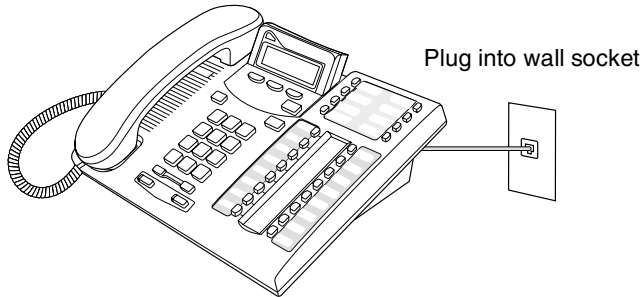
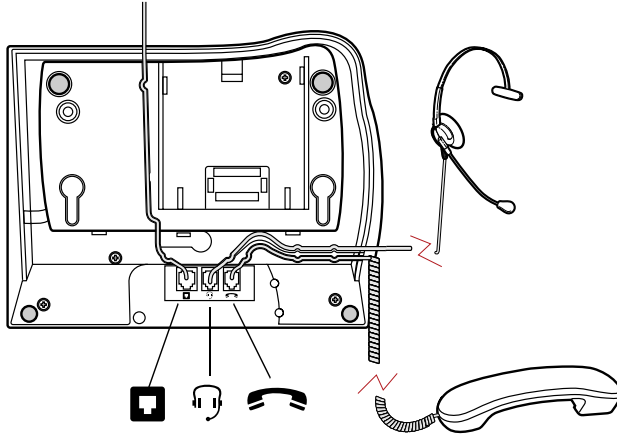

### Mounting a on the wall without angled base

Installing without the angled base

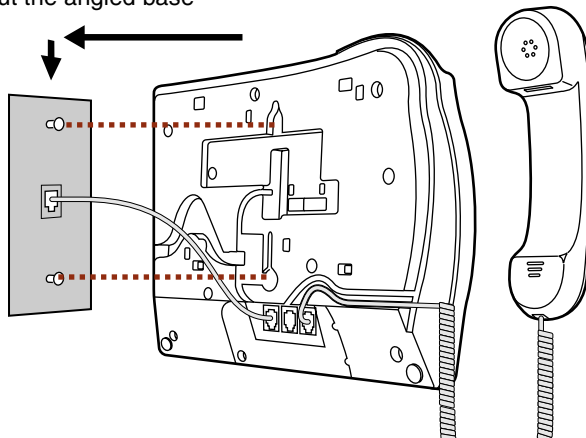

## Mounting on the wall using the angled base

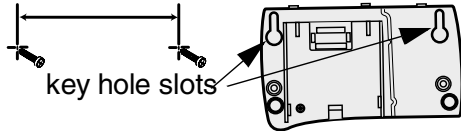
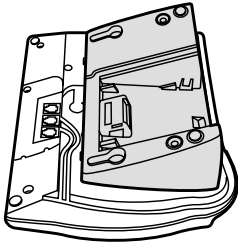

Use the key hole slots on the stand to mark the location for the screws. Tighten screws for a secure fit.

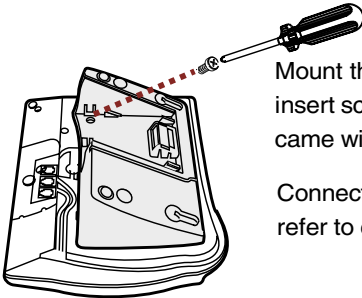

Mount the stand as shown and insert screw. Use the screw that came with your keystation.

Connect cords to the keystation, refer to cord connections

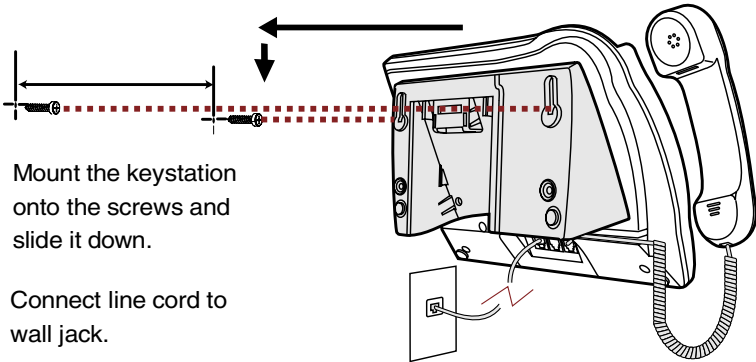

Mount the keystation onto the screws and slide it down.

Connect line cord to wall jack.

## Installing Norstar telephones

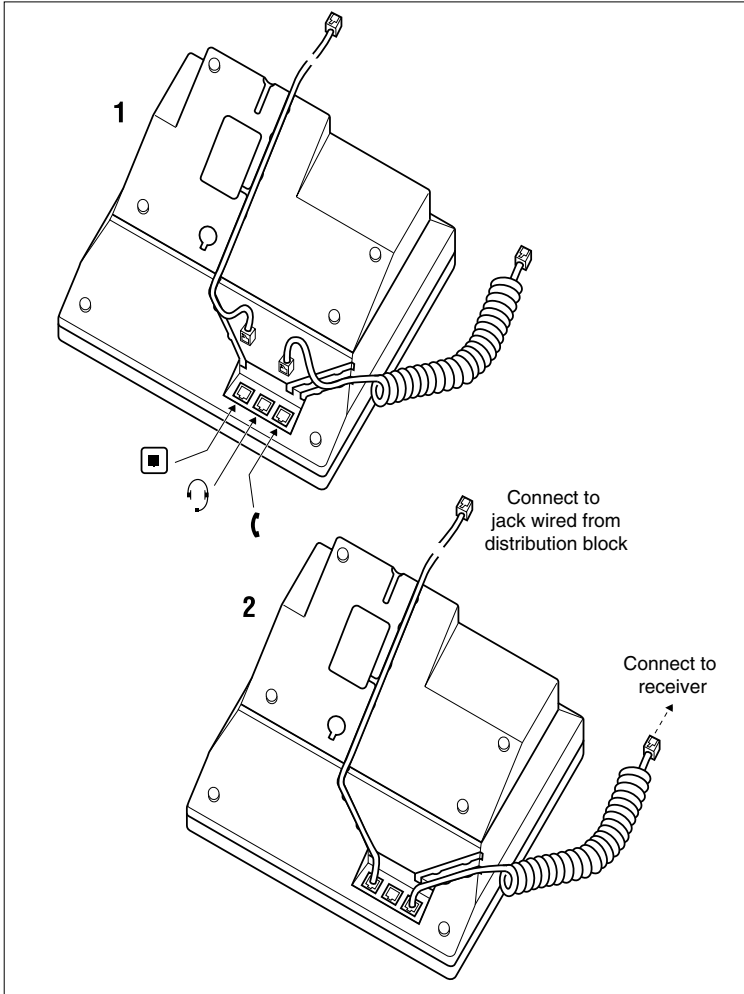

**Tip** - *Norstar telephones and telephones connected using the internal analog terminal adapter (I-ATA) cannot be used as off-premise extensions (OPX or OPS). For OPX applications, use the Norstar Analog Terminal Adapter (ATA) and a single-line telephone. See the ATA Installation Card for details.*

## Mounting Norstar telephones on the wall

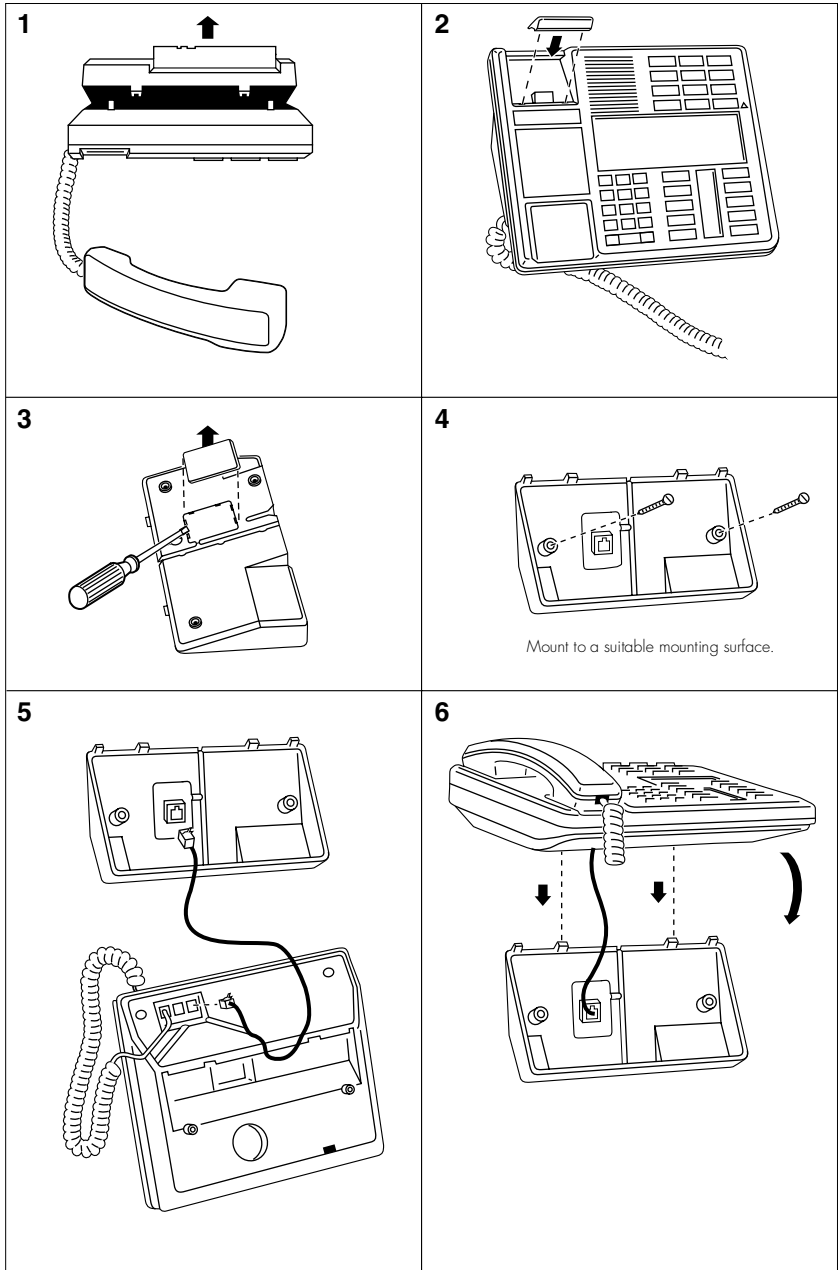

## Moving telephones

You can move a telephone to a new location within the Norstar system without losing its programmed settings. When Set relocation (automatic telephone relocation) is turned on in System programming, the internal numbers, autodial settings, and user speed dial codes remain with the telephone when it is unplugged. To move a telephone, simply unplug it and plug it in again at another location. It may take up to 45 seconds for the ICS to recognize the telephone. Automatic telephone relocation is turned off by default.



***Relocate old telephones before adding new telephones.***

Plug Norstar telephones in at their new locations so that they will retain their programmed settings. If a new telephone is plugged into the Norstar system before the old telephone is reconnected at a new location, Norstar will give the old telephone information to the new telephone, and the old telephone will no longer be recognized by the system.

***Do not move a relocated telephone for three minutes.***

The telephone must remain installed and connected in the new location for at least three minutes for the programming relocation to be complete. If you move the telephone again before the three-minute period, the programming for that telephone may be lost.

***Wait one minute before changing the DN of a relocated telephone.***

Once a telephone has been moved to a new location, it must be connected for a minute before you change its DN in System programming.



# Installing ISDN terminal equipment

For each S, T or U-LT reference point, an eight-position miniature unkeyed plug from the terminal equipment (TE) is plugged into a jack connected to Norstar wiring. The pin connections for the jack and plug are shown in the following charts.

For point-to-multipoint operation on S or T loops, ensure the wiring polarity integrity is maintained.

## S or T wiring for terminal equipment

Pin (jack or plug)	Norstar (S loop; for jack)	Equipment connection (plug)
1	not used	optional power source 3 (+)
2	not used	optional power source 3 (-)
3	+Rx	+Rx
4	+Tx	+Tx
5	-Tx	-Tx
6	-Rx	-Rx
7	not used	optional power sink 2 (-)
8	not used	optional power sink 2 (+)

## S or T extension wiring configurations

The last connection on any ISDN S or T extension wiring must have terminating resistors to ensure correct timing of the signaling circuits. Failure to install terminating resistors will degrade performance. Terminating resistors should not be connected on a TE which is not the last connection on the loop.

Terminating resistors are provided on terminal equipment. See the instructions that come with your TE for information on how to enable or disable the termination, as required.

The maximum length of spur and ISDN connection cord (the extension from the main line or bus) is 10 m (30 ft).

See the ISDN chapter for information about wiring arrangements for ISDN terminal equipment (TE) on an S or T loop.

## **Additional power**

A Norstar S-loop does not provide power on Power Source 1 (PS1), Power Source (PS2), or Power Source or Sink 3 (PS3). If you are installing ISDN terminal equipment at the S-reference point, and the equipment requires additional power on PS1, PS2, or PS3, then you can install a suitably approved power supply unit. See ANSI T1.605 or the documentation that comes with your TE for details.

The Compact ICS does not require power on PS3.

If a phantom circuit (a wiring arrangement using side circuits) is used to provide power to the TE (PS1), it may affect loop performance. You must account for any effects. For example, you may need to reduce the number of TEs on a passive bus.

## **U-LT wiring for terminal equipment**

<b>Pin (jack or plug)</b>	<b>Norstar connection (for jack)</b>	<b>Equipment connection (plug)</b>
1	not used	optional battery status indication (+)
2	not used	optional battery status indication (-)
3	not used	no connection
4	R	R
5	T	T
6	not used	no connection
7	not used	optional power (-)
8	not used	optional power (+)

No power supply is provided for the U-LT wiring. If equipment attached to the U-LT loop requires optional power, install an approved power supply unit. See ANSI T1.601-1992 Annex H or the documentation that comes with your TE for more information.

### Jack and plug pin numbering

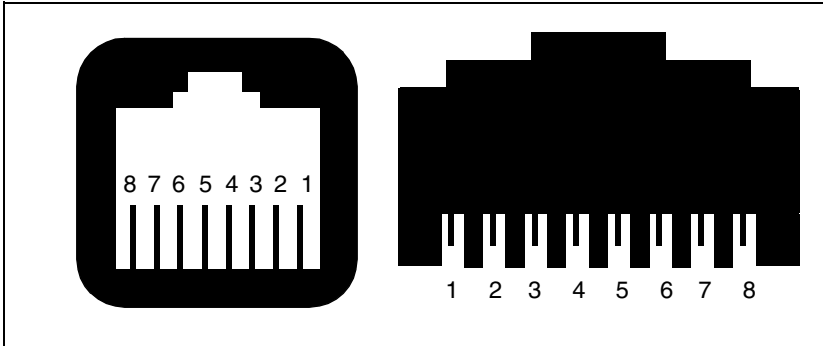

# Installing optional equipment

## Auxiliary ringer (customer supplied)

The Norstar ICS provides a control contact to operate an auxiliary ringer.

1. Follow the manufacturer's installation instructions.
2. Connect the auxiliary ring generator to the 25-pair distribution block as shown in the wiring charts. The pins in the chart provide a control contact. They do not provide ring current or dc voltage. The contact is capable of switching a maximum of 50 mA and a maximum voltage of 40 V dc.

## Auxiliary ringer programming

The auxiliary ringer can be activated by setting auxiliary ring for specific external lines, and auxiliary ring for specific telephones. Refer to the Programming chapter for details.

Heading	Programmed in:
Trunk/Line Data	Lines
Capabilities	Terminals&Sets
Ringing service	Services

## External music source (customer supplied)

The music source can be any approved low-power device such as a radio with a high-impedance earphone jack. The recommended ICS input level is 0.25 V rms across an input impedance of 3300  $\Omega$ .

1. Connect the music source output to the 25-pair distribution block ensuring the input ground is connected to the music source ground, as shown in the wiring chart beginning on page 90.
2. Adjust the volume of the music source to a comfortable level by activating Background Music (    ) and adjusting the volume at the music source.



**Tip** - Background Music volume can also be adjusted at each telephone.

## External music source programming

Music for callers on Hold and for Background Music must be enabled through programming. Refer to the Programming chapter for more details. Refer specifically to the following Programming headings and confirm that the following settings are implemented:

Heading	Setting
Featr settings	Backgrnd music: Y
	On hold: Music

## External paging system (customer supplied)

You can connect an external paging system to provide paging over external loudspeakers. The paging output from the Norstar ICS is 100 mV rms across an input impedance of 600  $\Omega$ .

1. Follow the manufacturer's installation instructions.
2. Connect the paging system audio input to the 25-pair distribution block as shown in the wiring charts.
3. Connect the paging system relay to the 25-pair distribution block as shown in the wiring charts.

### External paging contacts

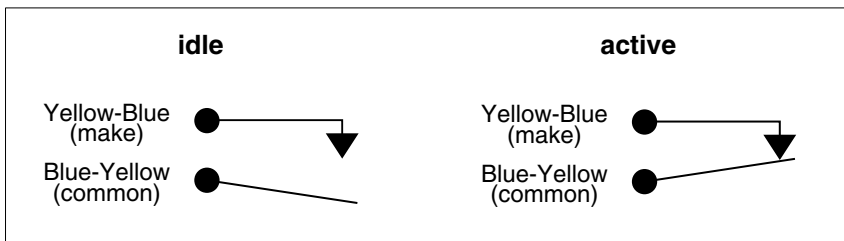



**Tip** - *Norstar external paging does not support talk-back paging equipment unless an external line port is used.*

*The Norstar system provides paging over the Norstar telephone speakers, even when no external paging equipment is connected.*

*Install all optional equipment before powering up the system.*

# Powering up the system



## ***Risk of fire and electrical shock.***

For continued protection against risk of fire and electrical shock, ensure all unpopulated cartridge slots are covered by filler faceplates prior to powering up. Immediately after powering up, connect the central office and station line connectors and replace the cover.

1. Ensure the filler faceplates (slot covers) are in place.
2. Make sure the air flows freely around the unit and that nothing is sitting on or blocking the area around it. The gap between the ICS and the backboard must be left completely clear.
3. Double-check all wiring. Do not connect the central office and station lines prior to connecting power.
4. Connect the power cord to an electrical outlet (non-switchable, third-wire ground AC outlet).



## ***Do not fasten power supply cords.***

To comply with UL1459, do not fasten the ICS power supply cord to any building surface, including the backboard.

5. Check that the power LED on the ICS is on.
6. Connect central office and station line connectors.
7. Replace the cover. Insert the tabs on the left side of the cover into the slots on the ICS, as shown in the illustration. Then press the cover until the tab on the right catches.

## Replacing the cover

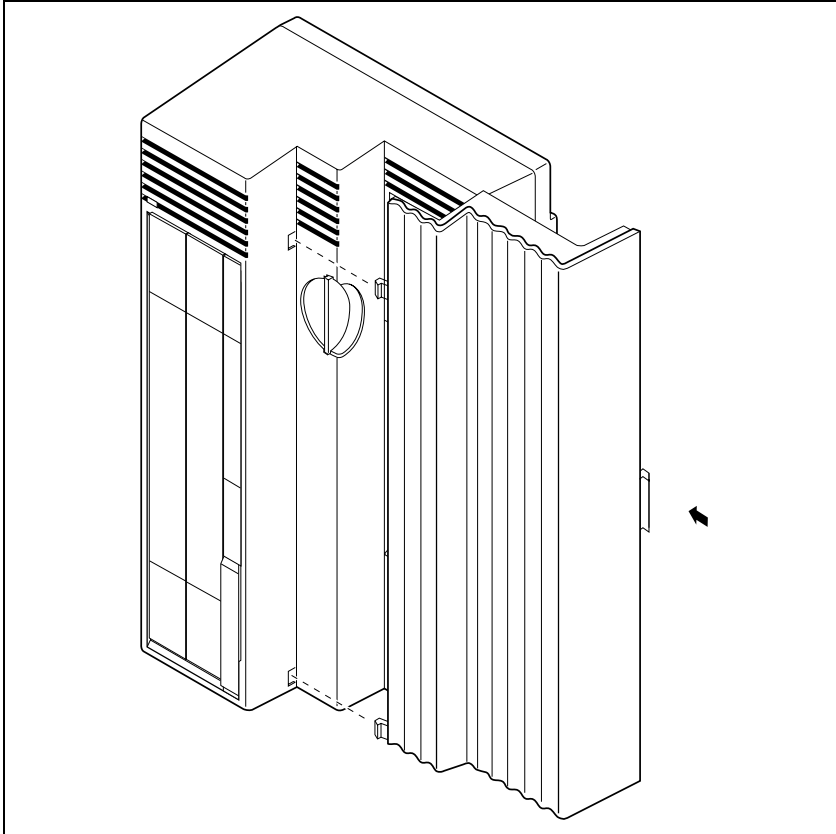

Once the system is initialized and the telephone displays shows ~~Jan 1 1:00 am~~, you have 15 minutes in which to perform Startup programming. Refer to *Startup programming* on page 130. After 15 minutes, access to Startup programming is denied. You can turn the system power off and back on if you need to access Startup programming after this point.



### ***Call Log information may be lost.***

If the Norstar system suffers a power failure or the system is manually restarted, Call Log information is not saved. Notify users if a system restart is planned so any log information can be written down first.



# Programming

The installer or the customer service representative programs settings for the entire Norstar system, plus settings for individual telephones and external lines. Most of the settings can also be programmed by a system coordinator who has a plus (SysCoord+) password.



## ***Programming affects system operation.***

Only a qualified installer or customer service representative should perform startup, installation and maintenance programming. Some of the settings affect the correct operation of the system.

## Programming overview

Programming access is controlled by these passwords.

- Profile password — allows you to determine the system profile. The default profile is the profile used for North American applications.
- Dialpad password — allows you to determine the style of dialpad programming for your system. This setting determines which key you press to obtain the letters Q and Z. The default is non\_CCITT (press 0 for both letters).
- Installer password – allows you to see and change any item in programming.
- System Coordinator Plus password – provides knowledgeable users with access to all but a few sensitive areas of programming.
- System Coordinator password – provides access to view and change the settings that are part of day-to-day administration of the Norstar system.
- Basic password – provides a limited number of feature codes to change programming and control system services.

The tables give an overview of what programming is seen by each type of user. For more information on programming the passwords, see page 134.

For more information about programming using the System Coordinator and Basic passwords, see the *Compact ICS 6.0 System Coordinator Guide*.

## Profile, Dialpad and Startup programming

Profile:  \* \* P R O F I L E (\*\*7763453)

Dialpad:  \* \* D I A L P A D (\*\*3425723)

Startup:  \* \* S T A R T U P (\*\*7827887)

Default password:       (266344)

Profile	Dialpad	Startup
Password: (CONFIG)	Password: (CONFIG)	Reset Memory? YES
Region: PROF1 OK    CHANGE	QZ:0 CHANGE	Template: CHANGE
		Start DN: 2221 CHANGE
		Applying Template (Install is complete when Date and Time appears on the display)

**Programming using the Installer and System Coordinator Plus password**

<b>Startup</b>		
Template		Network Services
Start DN		Release reasons
<b>Terminals&amp;Sets</b>		<b>Telco features</b>
Line access		VMsg ctr tel#s
Capabilities		<b>Software Keys</b>
Name		SysID
User prefernces		Password Keys
Restrictions		<b>Hardware</b>
Telco features		Cd1 on KSU
		Cd2 on KSU
<b>Lines</b>		<b>Maintenance</b>
Trunk/Line data		System version
Name		Port/DN status
Restrictions		Module status
Telco features		Sys test log
<b>Services</b>		Sys admin log
Ringing service		Provisioning
Restrn service		Tests
Routing service		Remote montr
Common set-tings		Usage Metrics
<b>Sys speed dial</b>		
	<b>Passwords</b>	
	COS pswds	
	Call log pswds	
	Progming pswds	
	IRAD pswd	
	<b>Time&amp;Date</b>	
	<b>System prgrming</b>	
	Hunt groups	
	Change DNs	
	Featr settings	
	Direct-dial	
	CAP assignment	
	Access codes	
	Auto Attendant	
	Fax DN	
	Remote access	
	Rec'd # length	
	DN length	
	Intrl modem	
	Hospitality	

Shaded items are seen only if you are using the Installer password. Settings that require an Installer password are identified with a special icon in the programming instructions.

The Auto Reporting subheading will not appear unless your Feature Cartridge comes with remote administration enabled, or you have enabled the feature using software keys.

**Programming using the System Coordinator password**

<b>Terminals&amp;Sets</b>	<b>Services</b>	<b>Time&amp;Date</b>
Capabilities	Ringing service	<b>System prgrming</b>
Name	Restrtn service	Hunt groups
User prfrnces	Routing service	Auto Attendant
Restrictions	<b>Sys speed dial</b>	Fax DN
Telco features	<b>Passwords</b>	Hospitality
<b>Lines</b>	Call log pswds	<b>Telco features</b>
Name	Progrming pswds	VMsg ctr tel#s

If you are new to programming, you may want to practice using the step-by-step programming instructions in *Getting Started* section of the *Compact ICS 6.0 System Coordinator Guide* before attempting other programming.

**Admin/Basic programming**

User code:        (\*\*3425723)

Default Basic password:      (22742)











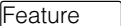

<b>Set ####</b>	
Model	Language
Button prgrming	Display cntrst
User speed dial	Ring Type
Call log opt'ns	Voice path
Dialing opt'ns	

## Programming tools

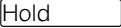
Two different programming overlays came in your documentation kit. Use the overlay that is appropriate for the telephone you are using to program your system.

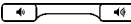
### Telephones

You can use a Business Series Terminal T7316 telephone or a Norstar M7310 or M7324 telephone for programming. These telephones have two-line displays. Use the appropriate template and refer to the table below to identify the keycap icons:

Business Series Terminals T7100, T7208, T7316, T7406	Button description	Norstar sets M7100, M7208, M7310, M7324
	<b>Feature</b>	
T7208 and T7316: Handsfree:  Mute: 	<b>Handsfree/Mute</b>	
 	<b>Hold</b>	 
	<b>Volume Control</b>	
	<b>Release</b>	

### The programming overlay

The programming overlay is a paper cutout that labels the four telephone buttons used during programming. One overlay corresponds to the Business Series Terminals T7316 telephone. The other overlay corresponds to the Norstar M7310 and M7324 telephones.

Use the appropriate programming overlay and put it over the buttons, as indicated in the following diagrams.

### Business Series Terminal T7316 with overlay

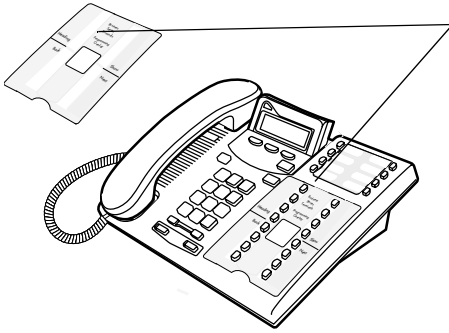

Place overlay over bottom set of memory buttons

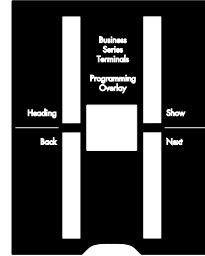

### Norstar M7310 and 7324 telephones with overlays



Place overlay over the four memory buttons on M7310 and M7324 telephones, as shown

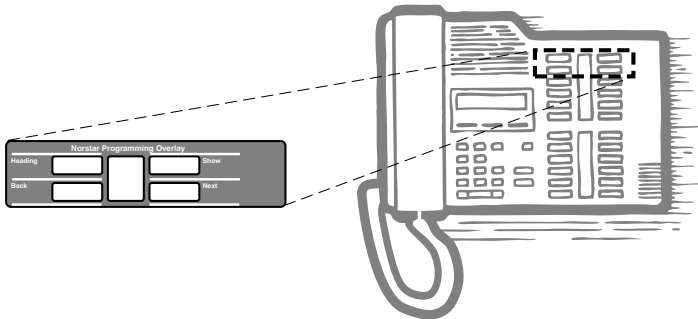
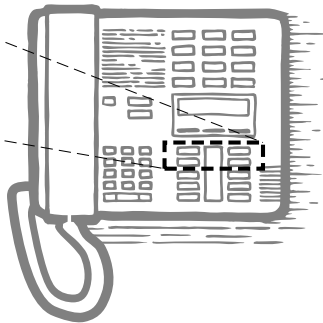

## Using the telephone buttons for programming

On the overlay, each of the four programming buttons is assigned an action feature.

The indicators (▶) on the display beside the buttons show which buttons are active at that programming step. By pressing the appropriate button, you can move up or down through the Norstar programming menu.

The table below describes the action of each button.

### Telephone overlay button definitions

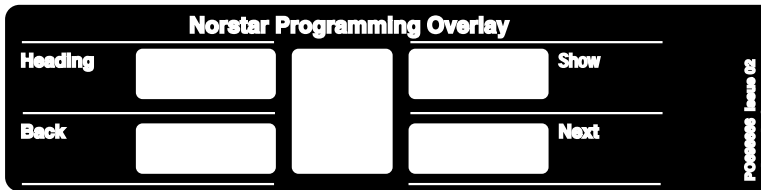

- moves to a higher level in the hierarchy of headings and subheadings.
- moves to a lower level in the hierarchy of headings and subheadings, or begins programming for a heading or subheading.
- moves forward at the same level in the hierarchy of headings and subheadings.
- moves backward at the same level in the hierarchy of headings and subheadings.

## The Norstar display buttons

Display buttons on the two-line telephones perform many functions. Depending on where you are in programming, one, two, or three display buttons may be available at any one time. Press the display button under the required function.

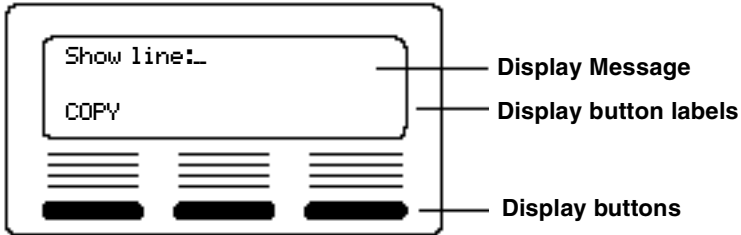

The most common display button labels are described in the following table:

### Display button definitions:

CHANGE	changes a programmable setting
BKSP	moves the cursor one space to the left (backspace) and deletes a character, allowing you to re-enter a number or letter
COPY	copies the settings of items like lines, telephones and filters to an item of the same type
LIST	displays the lowest value in a list of DNs, lines or other items
VIEW→	views the last part of a displayed message longer than 16 characters
←VIEW	views the first part of a displayed message longer than 16 characters
>	moves the cursor one position to the right when programming a name
<	moves the cursor one position to the left when programming a name
OK	confirms the change you made, or accepts the default, if you made no changes
ANY	adds a wild card character to a dialing sequence or destination code.



## Special characters on the display

When a heading ends with a triangle (▶), you can press  to view the subheadings for that item.

When a heading ends with an ellipsis (...), you can press  to see further information about that heading.

The indicators (▶) on the programming telephone shows which buttons can be used at that programming step. The functions on these buttons allow you to move through the headings and subheadings of Norstar programming.

## The Norstar Programming Record

Use the *Compact ICS 6.0 Programming Record* to plan your programming strategy. If you enter all your settings on the tables provided, you create a quick reference guide to your system.

Pages from the record may be photocopied, as necessary, for programming many telephones or lines.

## Exiting programming

Norstar stores your changes automatically as soon as you alter any settings. If you changed something in error, you must re-enter the correct data.

In extreme situations, you may have to restart the system and reload with your backup material.

To exit the configuration interface, press . The display briefly shows **End of session**, then returns to the Date and Time display.

## Viewing your programming updates

If any changes you have made to programming have not taken effect yet, you will see an **UPDATE** display button when you leave programming. The display will show you how many telephones have not been updated yet because the system is busy with other programming or the telephone is in use.

Press **DNS** to see the specific extensions where programming changes have not been updated. Items will disappear from the list as they are updated, and **UPDATE** will disappear once all changes are complete.

## Entering numbers

A line number must always be entered as a three-digit number. Line numbers from 1 to 8 must be entered with leading zeroes (for example, line 003).

Internal telephone numbers, also referred to as directory numbers (DNs), can be two to seven digits long. The default DN length is two digits. The DN length can be changed in programming.

## Copying telephone programming

Copying is done by using **COPY** under **Terminals&Sets**. You can copy programming from one telephone to another telephone, a range of telephones or all telephones.

1. At **Terminals&Sets** ▶, press  and enter the internal number of the telephone from which you wish to copy programming.

Select what programming will be copied:

- **SYSTEM** – the system administration programming (system data) of a set

OR

- **SYSTEM+USER** – the system administration programming PLUS the programming for a particular set (user data)

See the tables starting on page 124 to see which settings will and will not be copied with system and user data.

2. Press , then **CHANGE** to select the telephone or telephones which will be programmed with the copied data: **SINGLE**, **RANGE**, **ALL**.

You can copy programming to telephones which are not yet hooked up to the system (unequipped).

3. Press  , then **CHANGE** to select which telephones will be programmed: **Only equipped DNs, All set DNs**. This is not necessary when copying to a single telephone.
4. Press  and enter the internal number of the telephone that will be programmed or the internal numbers of the first and last telephone in a range.
5. Press **OK** to proceed with the copy. This step is not necessary when you are copying to a single telephone.

You can also use **COPY** to duplicate the settings found in the individual subheadings. The button is available in Line access, Capabilities, User preferences, Restrictions and Telco features and will copy only the settings included in the subheading. If you press **COPY** in one of these subheadings, you will not be asked to decide if user data will be copied. Otherwise, the procedure is the same.



**Tip** - *To copy to a group of telephones which are not part of a range, follow the steps for making a single copy and keep entering new numbers at the **COPY to:** display.*

*Depending on the activities going on in the system, a copy may not take effect for a while. The brief display you see once you have finished a copying session does not indicate the process is complete.*

*You can leave the programming session even if the copy has not been completed. If you exit programming, copying will continue uninterrupted until it is complete.*

*Event codes capture both the start and completion of the copying process. See the section on Event Codes in this guide for more information.*

*Some programming settings allow you to choose a delay according to the number of rings. The ring counts used are based on a North American standard of six seconds per ring cycle. The actual delay time may be different for a device other than a Norstar telephone.*

System Data which will be copied:	System data which will NOT be copied:
<p>Line access</p> <ul style="list-style-type: none"> <li>• Line assignment</li> <li>• Answer DN's (unless Answer button DN is same as set being copied to)</li> <li>• Line pool access</li> <li>• Prime line designation</li> <li>• Number of intercom keys</li> <li>• Outgoing line identification number</li> </ul> <p>Restrictions</p> <ul style="list-style-type: none"> <li>• Set restrictions</li> <li>• Set lock</li> <li>• Allow Last Number Redial</li> <li>• Allow Saved Number Redial</li> <li>• Allow Link</li> <li>• Line/set restrictions</li> </ul> <p>Capabilities</p> <ul style="list-style-type: none"> <li>• Allow redirect</li> <li>• Call Forward No Answer (DN + delay + setting)</li> <li>• Call Forward Busy (DN + setting)</li> <li>• Priority calling</li> <li>• Paging</li> <li>• Redirect ring</li> <li>• Auxiliary ringer</li> <li>• DND on busy</li> <li>• Hotline</li> <li>• Handsfree answerback</li> <li>• Handsfree setting</li> <li>• Direct-dial (which set is reached by the D-Dial digit)</li> <li>• Pickup group</li> <li>• Paging zone</li> <li>• ATA settings (except Use ringback setting)</li> </ul> <p>Telco Features</p> <ul style="list-style-type: none"> <li>• 1stDisplay</li> <li>• Caller ID set (<i>Auto call info</i>)</li> </ul>	<p>Line access</p> <ul style="list-style-type: none"> <li>• Private line appearances</li> </ul> <p>Capabilities</p> <ul style="list-style-type: none"> <li>• Set name</li> <li>• Use ringback setting under ATA settings (for I-ATA only)</li> </ul> <p>Telco features</p> <ul style="list-style-type: none"> <li>• Log password</li> <li>• Log space</li> </ul> <p>CAP assignment</p> <p>Direct-dial set designation (which set is the D-Dial set)</p> <p>ExtraDial set designation</p> <p>Service mode ringing set designation</p> <p>Prime set designation for a line</p> <p>Hunt group appearance</p>

---

<b>User data which will be copied:</b>	<b>User data which will be copied if destination set type is the same as the source set type:</b>
Language choice Ring type Calls log options ( <i>Auto logging</i> ) Display contrast Dialing options (automatic, pre-dial, standard)	External autodial button assignments Internal autodial button assignments Programmable button assignments

Ring volume, User speed dial and CAP module memory button programming are not copied with User data.

---

# Profiles and Dialpads

---

Use Profile programming to determine which types of trunks are supported, and which are supported on and off core.

Use Dialpad programming to define how your system will handle the letters Q and Z from the dialpad.



You must do this procedure **BEFORE** you run Startup, within the first 15 minutes after you plug in your KSU.

If you run this program after Startup, you will lose your settings.

## Profile programming

If your system is outside of North America, you may require a slightly different operating profile for your system. You must choose these parameters before you perform your system startup programming.

If your system is in North America or you know that you want to run that profile, you do not need to run this program.

## Profile parameters

Each market profile setting supports a different selection of trunk cards. In your situation you may require NI (primarily North America and some parts of South America) or ETSI (Europe, Asia, and some parts of South America) ISDN. Analog to digital expansion and compression rates can be either a-law or mu-law, as well. The tables in the following sections show which trunks are supported, and where.

**Note:** If you are unsure of the ISDN protocol or companding law active in your area, consult with your ISDN service provider for details.

## Profile 1

This profile is the default profile. It supports cards and protocols for Canada and the United States. This profile has language support for English, Canadian French, and Spanish. The mu-law companding law is used in this profile.

## Profile 2

This profile is for international systems that use ETSI ISDN lines with aLaw. The languages supported include: English, French, Spanish, and Turkish.

<b>Cards supported on-core</b>	<b>Cards supported off-core</b>
<ul style="list-style-type: none"> <li>• Analog</li> <li>• DTI</li> <li>• 4-port BRI-ST</li> <li>• 2-port BRI-ST</li> <li>• PRI (E1)</li> </ul>	<ul style="list-style-type: none"> <li>• Analog</li> <li>• E&amp;M</li> <li>• 4-port BRI-ST</li> <li>• 2-port BRI-ST</li> </ul>
<b>Supported</b>	<b>Not supported</b>
<ul style="list-style-type: none"> <li>• ETSI MCDN (SL-1) and EURO protocols</li> <li>• aLaw companding law</li> <li>• Loops are provisioned</li> <li>• T7000 telephone</li> </ul>	<ul style="list-style-type: none"> <li>• DID</li> <li>• UTAM</li> </ul>

## Profile 3

This profile provides language support in NA English, CDN French, US Spanish, and Turkey. This profile is for countries who use ETSI ISDN with mu-law (i.e. some Asian locations).

<b>Cards supported on-core</b>	<b>Cards supported off-core</b>
<ul style="list-style-type: none"> <li>• Analog</li> <li>• T1</li> <li>• 4-port BRI-ST</li> </ul>	<ul style="list-style-type: none"> <li>• Analog</li> <li>• E&amp;M</li> <li>• DID</li> </ul>

<ul style="list-style-type: none"> <li>• 2-port BRI-ST</li> </ul>	<ul style="list-style-type: none"> <li>• 4-port BRI-ST</li> <li>• 2-port BRI-ST</li> </ul>
<b>Supported</b>	<b>Not supported</b>
<ul style="list-style-type: none"> <li>• ETSI ISDN protocol</li> <li>• muLaw companding law</li> <li>• Loops are provisioned</li> <li>• T7000 telephone</li> </ul>	<ul style="list-style-type: none"> <li>• PRI</li> <li>• UTAM</li> </ul>

#### Profile 4

This profile provides language support in English, French, and Spanish. This profile is for countries who use NI ISDN protocol with mu-law (i.e. some areas in the Caribbean).

<b>Cards supported on-core</b>	<b>Cards supported off-core</b>
<ul style="list-style-type: none"> <li>• Analog</li> <li>• T1</li> <li>• PRI</li> <li>• 4-port BRI-ST</li> <li>• 2-port U</li> <li>• 4-port U</li> </ul>	<ul style="list-style-type: none"> <li>• Analog</li> <li>• E&amp;M</li> <li>• DID</li> <li>• 4-port BRI-ST</li> <li>• 2-port U</li> <li>• 4-port U</li> </ul>
<b>Supported</b>	<b>Not supported</b>
<ul style="list-style-type: none"> <li>• NI ISD protocol</li> <li>• muLaw companding law</li> <li>• PRI, including MCDN</li> <li>• T7000 telephone</li> </ul>	<ul style="list-style-type: none"> <li>• UTAM</li> <li>• Loops are not provisioned</li> </ul>



## Changing the profile

If your system is in North America or you know that you want to run the North American profile, you do not need to run this program.

If you need to change the profile, follow these steps:

1. Enter the Profile access code from a programming set by pressing \* \* P R O F I L E (\*\*7763453).
2. Enter the password, when prompted. (266344)
3. **Region:PROF1** displays. Press the key below **Change** to scroll to another profile number.
4. Click the display key for **OK** when you reach the profile you want to choose.
5. Press to exit.

## Dialpad programming

Use this program to determine how the system will recognize the characters Q and Z from a set dialpad. The two types of configurations are called CCITT and non-CCITT.

The default is non-CCITT, where Q and Z are accessed through the dialpad button.

CCITT systems access these characters through the (Q) and (Z) dialpad keys.

To change the setting, follow these steps:

1. Enter the Dialpad access code from a programming set by pressing \* \* D I A L P A D (\*\*3425723).
2. Enter the password, when prompted. (266344)
3. **Q,Z:0** displays. To change it, press the key below **Change**.
4. Press to exit.

# Startup programming

After the hardware has been installed and powered up, use Startup to initialize the system and select the Startup template.



## ***Startup erases programming.***

Startup erases any existing programmed data, and resets the system to factory defaults.

## Performing Startup

1. Enter the Startup access code from a two-line display telephone dialpad by pressing           which is the same as      .

To be accepted, the Startup code must be entered no later than 15 minutes after the Norstar system has been powered up and the telephone displays the time and date. If 15 minutes have elapsed since you powered up the system, turn system power off and on to prepare for the Startup process.)

2. Enter the Installer password. The default is       which is the same as      .



**Tip** - *The Installer password shown is the default normally used for Startup. For a system which has already been programmed, the Installer password might have been changed in programming and recorded in the Programming Record.*

## Changing the default template

After entering the Startup access code and Installer password the display shows **Reset memory?**.

1. Press **YES** to select a default template. The display shows the current template.
2. Press **CHANGE** to choose one of three templates (**Square**, **PBX**, or **Hybrid**). With the display showing the current template.
3. Press . The display shows the current start DN.
4. Press **CHANGE**.
5. Enter the new directory number you want as the starting DN and press **OK**. The display shows the new range of DN numbers.
6. Press  to store the programming. The display shows **APPLYING template**. The indicators begin to flash after a few moments, then the display returns to the date and time.



### ***Changing template resets system programming.***

If you change your system template, your system programming will be reset.

## Changing the starting DN number

You can change the starting number for your internal numbers, also known as directory numbers (DNs). This is helpful when your system is part of a network and you want to use a uniform series of internal numbers for all telephones in your network.



### ***DN numbering cannot conflict with direct-dial digit, park prefix or line pool and destination codes.***

If the new DN's clash with the direct-dial digit, park prefix, or line pool or destination codes, those numbers are overridden and set to None.



***Programming may be lost after three or more days without power.***

All programming is retained for three days if the power fails or if the Norstar system is powered off. After three days without power, it may be necessary to perform Startup.



**Tip** - *The length of the new DN (internal number) can be from two to seven digits.*

*Note: Systems that want to use Hunt Groups or Hospitality Services must have a minimum of three-digit DNs.*

*The length of the internal number that you enter sets the length for all internal numbers and target line received numbers in the system.*

*A DN length change, if required, should be the first programming change on a newly-installed Norstar system after you select a template.*

*If you reduce the length of the DN under System prgrming, the starting DN number is reset to the default value. For example, if you reset the DN length to 2 from a longer length, the start DN becomes 21.*

*If you increase the length of directory numbers under System prgrming, each increase in length places the digit 2 in front of any existing DN. For example, if DN 32 was increased to a length of 5, the new DN would be 22232.*

*Do not disable or enable ports in Maintenance during the first two minutes after Startup programming.*

---

# Programming

---

After performing Startup, use programming to change default settings as required. Default settings for the Square template are shown in bold.

Headings and subheadings in programming help you to keep track of where you are.

## Programming has the following main headings:

<b>Terminals&amp;Sets</b>	allows you to assign settings to each telephone.
<b>Lines</b>	allows you to assign settings to each trunk, external and target line.
<b>Services</b>	allows you to create services such as night ringing, routing and restrictions for making external calls.
<b>Sys speed dial</b>	allows you to create speed dial codes that can be used by any telephone in the system.
<b>Passwords</b>	allows you to view and change passwords for programming and features.
<b>Time&amp;Date</b>	allows you to set the time and date on the system clock.
<b>System Prgrming</b>	allows you to change system-wide settings, Auto Attendant and custom call routing programming.
<b>Telco features</b>	allows you to assign settings for external voice message services.
<b>Software keys</b>	allows you to upgrade a restricted feature cartridge or activate the remote administration feature using key codes supplied by Nortel.
<b>Hardware</b>	allows you to configure Trunk Cartridges and BRI Cards.
<b>Maintenance</b>	allows you to see diagnostic information about the system and provision BRI Cards.
<b>Usage Metrics</b>	allows you to see statistical information on Hunt groups

## Entering programming for installers

1. Press \* \* C O N F I G which is the same as \* \* 2 6 6 3 4 4 . The display shows **Password:**.
2. Enter the Installer password. The default password is **CONFIG** (266344). The display shows **Terminals&Sets** ▶. Three triangular indicators ▶ appear on the vertical display between the rows of buttons.
3. Place the programming overlay over the buttons pointed to by the indicators ▶.

## Entering programming for system coordinators

The person on staff who is in charge of making changes on the Norstar system is called the system coordinator. The everyday programming done by system coordinators is described in the *Compact ICS 6.0 System Coordinator Guide*.

Some system coordinators need to be able to program more advanced settings and functions in order to carry out the day-to-day requests and upkeep of the Norstar system. These coordinators are usually dedicated communications specialists who work with large Norstar systems or other telephone systems like a PBX or Centrex.

By using a special password, a system coordinator can see and change many, but not all, of the programming settings used by an installer. In this guide, programming that can only be changed by an installer is marked by a special icon. If you are programming using the System Coordinator Plus password, you will not see these items when you move through programming.

1. Press \* \* C O N F I G which is the same as \* \* 2 6 6 3 4 4 . The display shows **Password:**.
2. Enter the System Coordinator Plus password. The default password is **SCPLUS** (727587). The display shows **Terminals&Sets** ▶. Three triangular indicators ▶ appear on the vertical display between the rows of buttons.
3. Place the programming overlay over the buttons pointed to by the indicators ▶.

---

## Entering programming using other passwords

A set of the most often used headings and subheadings is available by using a System Coordinator password (see page 116). This level of access is designed for the person who takes care of the day-to-day changes to the Norstar system, but who is not interested in more advanced programming. The default password is ADMIN (23646).

There is also a Basic password that can be used to perform a few programming tasks. By using this password, a system coordinator can delegate some responsibilities while keeping more sensitive programming secure. See the *Compact ICS 6.0 System Coordinator Guide* for more information.

## Programming sequence

The programming information in this guide is presented in the order that is useful for everyday changes and upkeep of the system. The following order is more suitable for an installation.

Suggested order for programming a new installation:

- Startup
- Hardware
- Lines
- Terminals&Sets
- System prgrming
- Services
- Sys speed dial
- Telco features
- Software Keys
- Passwords
- Time&Date

---

# Terminals&Sets

---

Terminals&Sets allows you to assign settings to each telephone.

Press  and enter the extension number of the telephone you would like to program.

Press COPY to duplicate the programming for the telephone and apply it to another telephone, a range of telephones or all the telephones on the system. For more information about copying set programming, see *Copying telephone programming* on page 122.

## Line access

Line access allows you to assign lines to individual telephones.

When you are finished programming Line access settings for one telephone, you can copy those settings to other telephones by using COPY at the **Line Access** ▶ display. For more information about copying set programming, see *Copying telephone programming* on page 122.



**Tip** - *When you assign line access for BRI loops which have only one SPID, make sure that the programming for the two lines on a BRI loop is identical. For example, if line 001 on BRI loop 201 appears at a DN, line 002 on the same loop should appear at the DN as well. See the ISDN chapter for more information about programming BRI lines.*

*In general, auto-answer loop start trunks and auto-answer BRI trunks are not assigned to telephones. If assigned, they are used for monitoring incoming call usage, or for making outgoing calls.*



## Line assignment

This setting allows you to assign physical trunks and target lines to each telephone. Target lines are assigned and removed in the same manner as other lines. Press  and enter the line number. Press **CHANGE** to change the setting for each line: Appr&Ring, Appr only, **Unassigned**, or Ring only. Broadcast ring group ability is possible with multiple target line assignment across a group of sets.



**Tip** - Press **SCAN** to view the lines assigned to this telephone.

*In general, auto-answer loop start trunks and auto-answer BRI trunks are not assigned to telephones. If assigned, they are used for monitoring incoming call usage, or for making outgoing calls.*

*You cannot assign a line that is private to another telephone.*

*Each line assigned to appear at a telephone must appear at a button with an indicator on that telephone.*

*If you set a line to Ring only, incoming calls appear on an intercom button.*

*A central answering position (CAP) with a CAP module can provide extra line buttons. The remaining lines appear on buttons on the CAP module.*

*Make sure that lines assigned to M7100/T7100 telephones are assigned to ring; otherwise, you cannot detect incoming calls on the lines.*

## Appearances

This setting only applies for direct inward dial (DID) digits mapped onto target lines.

The Norstar system can handle simultaneous calls to set with multiple target line appearances. The number of target line appearances depends on the line assignment setting, which include: Appr&Ring, Ring only, Appr only.

If Appr&Ring or Appr only is chosen, you can have as many simultaneous DID calls as there are target line key appearances. If Ring only is chosen, you can have as many simultaneous DID calls as you have intercom keys.

The Basic Set, ATA, and BRI ISDN S-terminals cannot process more than 2 simultaneous calls.

There is a suggested limit of four keys per set. You can program more than 4 keys on an set by programming less than four on other sets. For instance, you might program 20 keys on a receptionist set equipped with a CAP.

The Norstar system will not support a mixture of Appear only and Ring only appearances.

1. Enter the line number. The display shows the line number and its assignment.
2. Press  until the display shows Appearances:1.
3. Press **CHANGE** and enter the number of target line appearances.
4. Press  to exit or  to continue programming.

## Line pool access

This setting allows a telephone to access one or more of the three line pools available (A to C). When you change the setting to yes for a given line pool, the telephone being programmed can access any lines in that line pool.

Press  and  to display the line pool to which you want to program access. Press **CHANGE** to select the setting: **N** (No) and **Y** (Yes).

## Prime line

This setting assigns a prime line to the telephone. A prime line is the first line that is automatically selected when the handset is lifted.

Press **CHANGE** to select the setting: **None**, a line number, Pool (A to C), and I/C (intercom). Only assigned lines and line pools appear.



**Tip** - *An assigned prime line is not associated with the assignment of a prime telephone.*

*An external line must be assigned to the telephone in Line assignment before it can be assigned as the prime line to the telephone.*

*A line pool must be assigned to the telephone in line pool access before a line pool can be assigned as the prime line to the telephone.*

*By assigning a line pool as a prime line, a telephone can be made to search automatically for an idle line in a pool. See Line type on page 157 for more information.*

*If you set Prime line to I/C (intercom), you can still access any line pools which you have assigned to the telephone. When you enter the line pool access code, the system searches for an idle line in that pool. When all the lines in the pool are busy, the display will show No free lines. The system will not search from one pool to another.*

## Intercom keys

This setting assigns the number of intercom buttons to a telephone. Intercom buttons can provide a telephone with access to internal lines and line pools. Press **CHANGE** to select the setting: 0, 1, 2, 3, 4, 5, 6, 7, or 8.



**Tip** - *Each intercom button assigned during programming automatically appears on the telephone. The buttons start with the lower right-hand button, or one button above if the Handsfree/Mute feature is assigned to the telephone.*

*A telephone needs two intercom buttons to be able to establish a conference call with two other Norstar telephones.*

*Only one intercom button may be required if the button will only be used to access line pools and to make and receive internal calls.*

*If a telephone has several lines assigned only to ring and not to appear, the arrangement will work better if there are two intercom buttons.*

*The M7100 and T7100 telephone default assignment of two intercom buttons can be changed to up to eight buttons. These buttons do not appear on the telephone.*

*A target line cannot be a prime line for a telephone because it is incoming-only.*

## Answer DNs

Calls for other Norstar telephones can appear and be answered at the telephone being programmed. The DNs of the other telephones are referred to as Answer DNs. You can assign up to eight Answer DNs to the telephone being programmed. Press  **Show**  and enter the Answer DN. Press **CHANGE** to change the setting for the Answer DN: Appr&Ring, Appr only, or **Unassigned**.

To assign additional Answer DNs, press  **Heading** , then enter the next Answer DN



**Tip** - Press SCAN to view the Answer DNs assigned to this telephone.

*Every Answer DN assigned to the telephone automatically assigns an Answer button with an indicator to the telephone. These buttons should be labeled accordingly, identifying the telephone with its name or DN.*

*Any number of telephones can have an Answer button for the same DN. In this way, more than one telephone can provide call alerting and call answering for any calls directed to that DN.*

*A private line does not generate alerting at an Answer button. You cannot assign Answer DNs to an M7100 and T7100 telephone, or to a single-line telephone connected to an Analog Terminal Adapter.*

## OLI #

When you make an outgoing call on a BRI line, the Call Display information which appears on the telephone you are calling is usually based on the first Network DN associated with the service profile identifier (SPID) and line.

If the SPID and line have more than one Network DN, you can program a DN to use a Network DN other than the first one for the outgoing Call Display information. When you program the alternate Network DN as the outgoing line identification (OLI) number, and you make a call using the line associated with the Network DN, the OLI number appears on the telephone you are calling.

If an outgoing call is made using a SPID and line that are not associated with the Network DN number used as the OLI number, the network ignores the number and the default Call Display information (the first or only Network DN associated with the SPID and line) is displayed.

Press CHANGE and enter the digits used for the OLI.

Press CLR to choose **None**.

## Capabilities

Settings that control how the system interacts with individual telephones and the calls they receive are found in Capabilities. The default settings are given in bold.

Setting	Description	Options
Fwd no answer		
Fwd to	Redirect all incoming calls to this telephone when this telephone does not answer.	Enter DN <b>None</b>
Forward delay	Select the number of rings before an unanswered call is forwarded.	2, 3, <b>4</b> , 6, 10
Fwd on busy	Redirect all incoming calls when this telephone is busy with another call.	Enter DN <b>None</b>
DND on Busy	Select whether an incoming call rings if the user is already on another call.	<b>Y</b> , N
Handsfree	Select whether Handsfree will be available to a telephone.	Auto, Std (Standard), <b>None</b>
HF answerback	Select whether a user can automatically answer a voice call without lifting the handset or without pressing the key marked Handsfree/Mute.	<b>Y</b> , N
Pickup grp	Assign this telephone to a pickup group.	<b>None</b> , 1, 2, 3, 4
Page zone	Assign this telephone to page zone.	None, <b>1</b> , 2, 3
Paging	Select whether paging announcements can be made from this telephone.	<b>Y</b> , N
D-Dial	Select whether you can call the Direct-dial telephone from this telephone using the Direct-dial digit.  Note: The direct dial digit for the system is chosen under Access Codes.	<b>Set 1</b> , None
Priority call	Select whether to allow this telephone to interrupt calls or to override Do Not Disturb at another telephone.	<b>Y</b> , N

<b>Setting</b>	<b>Description</b>	<b>Options</b>
Hotline	Select whether a telephone number will be dialed automatically when a user lifts the handset or presses the key marked Handsfree/Mute.	Intrnl, Extrnl (enter DN), <b>None</b>
Intrnl #	Appears if Hotline is Intrnl	Enter DN, <b>None</b>
Extrnl #	Appears if Extrnl	<b>None</b> , <up to 24 digits>
Aux. ringer	Select whether an auxiliary ringer (if installed) will ring for incoming calls at this telephone.	Y, <b>N</b>
Allow redirect	Select whether to allow this telephone to redirect its lines.	Y, <b>N</b>
Redirect ring	Select whether a telephone rings briefly when a call on one of its lines is redirected by the Line Redirection feature ( <input type="checkbox"/> <input type="checkbox"/> <input type="checkbox"/> ).	<b>Y</b> , N

For more programming information, see the *Compact ICS 6.0 System Coordinator Guide*.

## ATA settings

### ATA ans timer

A timer can be used to administer a delay between the last digit you dial on a device connected to an analog terminal adapter (ATA) and when the system begins to send out tones (DTMF or modem) on the outgoing line without capturing and interpreting them. To change the delay time, press **CHANGE** to select the setting (in seconds): ATA ans timer: 3, 5, 7, or 10.

If the DN you are programming is the internal analog terminal adapter (I-ATA), you may also select **Use ringback**. When this setting is used, the system will send out tones without capturing and interpreting them when it detects ringback, or after 10 seconds, whichever comes first.



**Tip** - *To accommodate the device attached to the ATA, you may want to lengthen or shorten the delay. If a modem or fax machine is attached to the ATA you will want to keep the delay short. If a call to a fax machine or modem cannot be connected, try shortening the delay. If an individual is dialing the number for a fax machine or modem, you may want to make the delay a little longer.*

### ATA use

An analog terminal adapter (ATA) can connect to devices that are either on your premises or at some other location. Press **CHANGE** to select **On site** or **Off Site**. This setting does not appear when you are programming the DN for the I-ATA.

### ATA dvc

Devices connected to the system through an ATA can have connectivity issues over BRI/PRI lines. To alleviate this, you can specify the type of device.

Press **CHANGE** to select On **telephon** or modem.



## Name

The default name for a telephone is its DN, but it can be changed to any combination of letters and numbers to a maximum length of 7 characters.

For more information, see the *Compact ICS 6.0 System Coordinator Guide*.

## User preferences

Any programming that can be done by users at their telephones can also be done in programming under User preferences. The default settings are given in bold.

Setting	Description
Model	Allows you to pre-program the model of Norstar set which will use this DN (M7208). If you want to program the set with a CAP module, change the model to M7324.
Button prgrming	allows you to program the buttons with internal and external autodialers and/or programmed feature keys.
User speed dial	Programs user speed dialers (No defaults).
Call log opt'ns	Select whether the set will: log all calls, no calls, calls which were not answered by this telephone, or calls which no one answered.
Dialing opt'ns	Select standard dial, pre-dial or automatic dial.
Language	Choose the display language: English, French or Spanish (which languages are available depends on the profile set for your system).
Display cntrst	Adjust the contrast of the display (4).
Ring type	Select a ring type (1).
Voice Path	Select handsfree or headset.

For more information, see the *Compact ICS 6.0 System Coordinator Guide*.

## Restrictions

Restrictions prevent a user from making certain kinds of calls from a telephone or from lines that are available at the telephone, and restricts some features.

When you are finished programming restriction settings for one telephone, you can copy those settings to other telephones by using **COPY** at the **Restrictions** ▶ display. For more information about copying set programming, see *Copying telephone programming* on page 122.

## Restrnr filters

A restriction filter is a set or group of restrictions and overrides that specify the external numbers or feature codes that cannot be dialed from a telephone or on a line. Rather than define individual restrictions and apply them repeatedly to telephones and to lines, restriction filters allow you to assign them in one step as a single package of dialing sequences that are not permitted.

In addition to restricting telephone numbers, you can prevent people from entering dialing sequences used by the central office (the public network) to deliver special services and features. Because some of these features provide the caller with dial tone after they have entered the special code (which often uses **#** or **\***), users may have an opportunity to bypass restrictions. To prevent this from happening, you should create filters that block these special codes.

You create a filter by defining the dialing sequences that are denied. There will also be variations of each sequence that you will want users to be able to dial. Sequences that can be dialed are called overrides.

Once you create the filters, you can assign the restrictions to a telephone (under Terminals&Sets), to a line (under Lines), to a particular line on a telephone (under Terminals&Sets), and to remote callers (under Remote access).

- Press  and enter the number of the restriction filter you want to program or press  to move through all the available filters.
- Press  to see the first restriction in the filter. The first four digits of the number that will be denied are included in the display. The full number can be seen by pressing  again.

- Use **ADD**, the dialpad, and **OK** to program a restriction for each filter.
- Press  when the full restricted number is on the display (it shows **Deny:** and the number) to see any overrides to the restriction.
- Use **ADD**, the dialpad, and **OK** to program one or more overrides for each restriction filter.
- Press **ANY** to enter a • wild card character that represents any digit in a sequence of numbers when denying numbers or creating overrides.
- You can press **REMOVE** to delete a restriction. The overrides will be deleted as well and the restrictions will renumber to fill the gap.

## Default filters

Filter 00 permits unrestricted dialing and cannot be changed.

Filter 01 is preprogrammed with five restrictions and some associated overrides. In Filter 01, restriction 02 and override 005 allow long distance directory assistance calls. Filter 01 reflects the fact that area codes can now have any digit as a second digit. This is also consistent with the new North American dialing plan.

The dialing string 911 (the number for emergency assistance in North America) is included as both a restriction and an override in filter 01. This arrangement prevents anyone from blocking calls for emergency assistance on lines or sets using the default filter.

### Restriction filter defaults

Filter	Restrictions (denied)	Overrides
00	Unrestricted dialing	
01	01: 0	
	02: 1	001: 1800 002: 1888 003: 1877 004: 1555 005: 1•••555
	03: 911	001: 911
	04: 411	
01	05: 976	
02 - 99	No restrictions or exceptions programmed	

Filters 02, 03, and 04, although not preset with restrictions and overrides, are used as default filters in these programming headings.

Filter	Heading	Sub-heading
02	Terminals&Sets	Set restrns:
03	Lines	Line restrn:
04	Lines	Remote restrn:



**Tip** - *Filter 00 cannot be changed.*

*Norstar can have up to 100 restriction filters (00 to 99).*

*Each programmable filter can have up to 48 restrictions. There is no limit on the number of overrides that can be allocated to a restriction. There is a maximum of 400 restrictions and overrides allocated to the 100 programmable filters. The maximum length of a restriction is 15 digits. The maximum length of an override is 16 digits.*

*A solid dot (•) in a dialing sequence is a wild card (stands for any digit). It is inserted by pressing **ANY**.*

*You can use **\*** and **#** in a sequence of numbers in either a restriction or an override. These characters are often used as part of feature codes for other systems or for features provided by the central office (the public network).*



**Tip** - *When restricting the dialing of a central office feature code, don't forget to create separate restrictions for the codes used for DTMF and pulse lines. Examples of dialing strings that may be restricted for this reason are \*67 and 1167.*

*Do not string together a central office feature code and a dialing sequence that you want to restrict. Create a separate restriction for each.*



**Tip** - You can use **COPY** and the dialpad to copy restrictions and overrides from one filter to another.

Any restriction or override can be used in any number of filters. Each time it is used, it counts as one entry. For example, if restriction 411 exists in filters 01, 02 and 03, it uses up three entries of the 400 entries available.

Removing a restriction from a filter has no effect on the contents of other filters, even if the restriction was copied to them.

You cannot delete a filter. Removing the restrictions programmed on a filter makes it an unrestricted filter, but the filter itself is not removed.



**Removing a restriction changes the identifying number of the restriction.**

Removing a restriction also removes the overrides associated with it, and changes the identifying number of the restriction. For example, removal of restriction 01 renumbers restrictions 02 to 08 as 01 to 07.

## Set restrns

Set restrictions allows you to assign a restriction filter to a telephone to prevent certain numbers from being dialed from that telephone. You can assign a different restriction filter for normal service and for each of six schedules. See the section on Services for more information about the schedules.

Use  , **CHANGE** and the dialpad to enter the number of the restriction filter to be assigned to the set for each schedule. The default restrictions are as follows:

## Default filters for sets

Schedule	Restriction filter	
Normal	02	
Sched 1 (Night)	11	
Sched 2 (Evening)	12	
Sched 3 (Lunch)	13	
Sched 4	00	
Sched 5	00	
Sched 6	00	

This means, for example, that if you enter a set of restrictions for filter 11, they will be automatically applied when the Night schedule is in use.

## Set lock

Set lock controls the level of personal programming and customizing that can be performed at a telephone. Press **CHANGE** to select the type of set lock: Full, Partial, or **None**.

A full description of the levels of set lock is included in the *Compact ICS 6.0 System Coordinator Guide*.

## Allow last no

A telephone can be prevented from using Last Number Redial (  5). Press **CHANGE** to select the setting: **Y** (Yes) or **N** (No).

## Allow saved no

A telephone can be prevented from using Saved Number Redial (  6  7). Press **CHANGE** to select the setting: **Y** (Yes) or **N** (No).

## Allow link

A telephone can be prevented from using Link (  7  1), a host signaling option. Press **CHANGE** to select the setting: **Y** (Yes) or **N** (No).

## Line/set restrns

Line/set restrns allows you to assign a restriction filter to a specific line that can be used for outgoing calls at a specific telephone. This type of filter replaces any line or set restriction filters which might otherwise apply. It restricts the numbers you can dial on a line, but only from that telephone. The same line on another telephone can have different restrictions.

As with set restrictions, you can apply a different line/set restriction for normal service and for each of six schedules.

Use  , **CHANGE** and the dialpad to enter the number of the filter to be assigned as the line/set restriction for each schedule. There are no default line/set restrictions.



**Tip** - *A maximum of 255 line/set restrictions may be applied to lines at telephones.*

*If a line/set restriction is assigned to a line at a particular telephone, it overrides any line restrictions or set restrictions which might otherwise apply.*

*If no line/set restrictions have been defined, the numbers are checked against the set restrictions and the line restrictions, if either of these have been defined. The numbers may be rejected by either restriction.*

## Telco features

Telco features can program the way the Norstar works with features and services that are based in the public network or other outside source. Norstar is designed to work with two of these kinds of services: Call Display and an external voice message service.

When you are finished programming Telco features settings for one telephone, you can copy those settings to other telephones by using **COPY** at the **Telco features** display. For more information about copying set programming, see *Copying telephone programming* on page 122.

## Feature assignment (CLID alignment)

If you subscribe to Call Display services (often called Caller ID) and the Compact ICS is equipped with a Global Analog Trunk Cartridge (GATC) with CLID (or a Call Information (CI) Trunk Cartridge), external calls are identified on the display. You may also have a message indicator from an external voice mail service show on the display. CLASS assignment programming allows you to customize how this information is used.

Press  and enter the number of the line you want to program with CLASS settings for the telephone.

## Caller ID set

Caller ID set allows you to specify if a telephone displays the Call Display information when a call is ringing on an external line. After the call is answered, Call Display information is always shown at the telephone that answered the call.





The Caller ID set for target lines is the same set that has appearance on that target line. Press **CHANGE** to select the setting: N (No) or Y (Yes).





Sets which are part of a CCR group (used with Auto Attendant features) receive Call Information automatically for all CCR calls. When a call is routed to the CCR group by the CCR, information about the call appears at all the sets in the group. This capability is part of the CCR group assignment. No other programming is needed. See the *Compact ICS 6.0 System Coordinator Guide* for more information.



**Tip** - *In order for a telephone to display the Call Display information for calls on an external line, it must also be programmed to appear and ring or ring for that line.*



*For systems that subscribe to Call Display services, Caller ID can be viewed on any telephone by entering the Call Information feature code     . See the Telephone Feature Card or Compact ICS 6.0 System Coordinator Guide for more information.*

*Call information does not automatically appear when the telephone has an Answer DN, or belongs to a Ring group activated by Ringing Service. Call information is still available for these calls by pressing     .*

## Extl VMsg set

If you subscribe to a voice message service, you can access that service through your Norstar system. The external voice message setting controls where the indicator shows up when there is a voice message waiting on a particular line. The line must appear on that telephone. Press CHANGE to select the setting: N (No) or Y (Yes).



**Tip** - *To find out if your voice message service will work with Norstar, or if you have any problems with your service, contact your voice message service provider.*

## 1st Display

Depending on the services you subscribe to, Call Display information may contain up to three parts: the name of the caller, the number of the caller, and the name of the line in your Norstar system that the call is on. For each telephone, you can determine which information is displayed first. Press CHANGE to select the setting: **Name**, Number or Line.

See the *Compact ICS 6.0 System Coordinator Guide* for more information.

## Log space

Log space determines the number of items that can be stored in the Call log for each telephone. Use  , **ADD** and **REMOVE** to redistribute the log space. There is no log space assigned by default.



**Tip** - *There must be space available in the log pool in order for you to add space to a Call log. The maximum number of spaces available is 250.*

*System-wide log space allocation is performed in Call log space under System prgrming. If you want to allocate the same log space to all telephones, use the Call log space setting instead.*

# Lines

## Trunk/Line data



Installer password required

Trunk/Line data allows you to program settings for lines that affect how the Norstar communicates with the public network and other switches. Line data allows you to determine how lines (including target lines) will be used in the Norstar system.

Some Trunk/Line data settings may not appear on the display during programming depending on the type of trunk. Those that appear for a given Trunk type are indicated in the following table.

### Trunk/Line data settings that appear for a given trunk type

Setting	Loop start	BRI-ST, BRI-U2,BRI-U4	Target lines
Trunk type	✓	✓	—
Line type	✓	✓	✓
Dial mode	✓	—	—
PrimeSet	✓	✓	✓
Auto privacy	✓	✓	✓
Trunk mode	✓	—	—
Ans mode	✓	✓	—
Ans with DISA	✓	✓	—
Aux. ringer	✓	✓	✓
Full AutoHold	✓	✓	—
LossPkg	✓	—	—
Rec'd #	—	—	✓
If busy	—	—	✓
Distinct Ring	✓	✓	✓

## Copying Trunk and Line data

At the **Trunk/Line data** ▶ display **COPY** appears. This allows you to copy programming from one line to other lines.



**Tip** - *In copying data from a physical trunk to a target line (or the other way around), only the data in common is copied. For example, copying a target line to a loop start trunk will not copy the Rec'd # setting because that setting is unique to target lines.*

*If you try to copy line programming between lines on different types of Trunk Cartridges, the display shows **INCOMPATIBLE TC**, then returns to **Show line:**. You cannot copy programming between lines on different types of Trunk Cartridges.*

*The Received number of a target line is a unique number and cannot be copied.*

### Trunk type



Installer password required

Trunk type shows the type of Trunk Cartridge or BRI Card on which the line is found. It can be Loop, BRI-ST, BRI-U2, or BRI-U4.



**Tip** - *This display is determined by the Trunk Cartridge or BRI Card. The system simply displays the trunk type; you cannot change the setting.*

## Line type



Installer password required

This setting specifies how the line is to be used in the system. Press **CHANGE** to select the setting: **Public**, **Private to:**, or **Pool (A to C)**.

- A public line can be accessed by more than one telephone.
- A private line can be assigned only to one telephone and the prime telephone for that line. Use **CHANGE** and the dialpad to enter the internal number of the telephone.

If you try to make private a line that is answered by CCR (an Auto Attendant feature) or used for transmitting alarm codes, you will be asked if you wish to reconfigure the line before it is made private. Private lines are not available for use with CCR and alarm code reporting.

- Pool assigns the line to one of the three line pools. If a line is assigned to a line pool, but is not assigned to any telephone, that line is available only for outgoing calls.



**Tip** - *Try to avoid putting unsupervised loop start lines in a line pool. These lines can become hung, especially when a remote user uses the line pool to make an external call.*

*Before a line pool can be used you must assign line pool access to telephones in LineAccess under Terminals&Sets, and create system-wide line pool codes in Access Codes under System prgrming.*

*A telephone can be administered to search automatically for an idle line from several lines appearing on the telephone. Assign a line pool as the prime line (in Line Access) and all the lines in the line pool to appear on that telephone. When the user lifts the handset or presses the button marked Handsfree/Mute, any one of the lines, if idle, can be selected by automatic outgoing line selection.*



**Tip** - When you set prime line to I/C (intercom), the system chooses the first available line after searching the line pools, starting with line pool A.

You cannot assign target lines (061-086) to a line pool.

## Dial mode



Installer password required

Dial mode allows you to specify whether dual tone multifrequency (DTMF) or pulse signalling is used on the trunk. Press CHANGE to select the setting: Pulse or **Tone**.

## Prime set



Installer password required

This feature allows you to assign a telephone to provide backup answering for calls on the line. Unanswered calls are redirected to the prime telephone if DRT to prime is set to Yes. Use CHANGE and the dialpad to enter the internal number of the prime telephone.

The default prime telephone for each line is **21**.



**Tip** - Each line can be assigned only one prime telephone.



## Auto privacy



Installer password required

This feature controls whether one Norstar user can select a line in use at another telephone to join an existing call. The default setting is Privacy on, so that nobody with a Norstar telephone can press a line appearance on their telephone to join a call in progress at another telephone. Press **CHANGE** to select the setting: **Y** (on) and **N** (off).



**Tip** - Users can change a line privacy setting for an individual call using the privacy feature (    ).

## Trunk mode



Installer password required

Trunk mode allows you to specify one of two modes of operation for each line: disconnect supervision or unsupervised. Disconnect supervision, also referred to as loop supervision, releases an external line when an open switch interval (OSI) is detected during a call on that line. This prevents the line from remaining unavailable for other Norstar users.

Press **CHANGE** to select the setting: **Unspr** or **Super**.

- **Unspr** turns disconnect supervision off for the line.
- **Super** (the default) assigns supervised mode, if supported by the line; otherwise, the line functions as unsupervised.



**Tip** - *The duration of an open switch interval (OSI) before Norstar disconnects a call is programmed by the Discon timer setting under Hardware programming.*

*Disconnect supervision is required for loop start trunks to operate in auto-answer mode or with DISA. It is also required to conference with two external callers.*

*The line must be equipped with disconnect supervision from the central office for the Super option to work.*

## Ans mode



Installer password required

The Answer mode setting appears on the display during programming for loop start and BRI trunks if the Trunk mode setting is Super. Press CHANGE to select the setting: **Manual** or Auto.



**Tip** - Remember that disconnect supervision is required if loop start or BRI trunks are to operate in auto-answer mode.

## Ans with DISA



Installer password required

When activated, the Answer with DISA setting specifies that a trunk is answered with stuttered dial tone. Press CHANGE to select the setting: **Y** (Yes) or **N** (No).



**Tip** - This setting only appears if Answer mode is Auto.

## Aux. ringer



Installer password required

This setting allows you to turn the auxiliary ringer on or off. When turned on, the auxiliary ringer rings for any incoming calls that ring on the line. The auxiliary ringer is an optional device that must be connected by the installer. Press CHANGE to select the setting: **Y** (Yes) and **N** (No).





**Tip** - An auxiliary ringer can be programmed, (Services in Ringing Service) to ring for a line placed into a scheduled ringing service. An auxiliary ringer can also be programmed to ring for calls to a telephone. See the Compact ICS 6.0 System Coordinator Guide for more information.

*If you have an auxiliary ringer programmed to ring for calls on an external line, and you transfer a call on that line without announcing the transfer, the auxiliary ringer will ring for the call transfer.*

## Full AutoHold



Installer password required

Full AutoHold on idle line is a variation of the Automatic Hold feature. If you select an idle line, but do not dial any digits, that line is automatically placed on hold if you then select another line. Press CHANGE to select the setting: N (No) or Y (Yes).

The line you first selected is held until you press its button. The line is not available for use by anyone else.



**Tip** - The default setting should be changed only if Full AutoHold is required for a specific application. For instance, if you define system-wide access keys (SWCA) for telephones, Full AutoHold must be active on those telephones for the feature to act correctly.

## LossPkg



Installer password required

Loss Package allows you to select the appropriate loss/gain and impedance settings for each line. The setting is based on the distance between the ICS and the terminating switch, and the terminating switch type.

The following table shows the available settings.

LossPkg	Receive Loss	Transmit Loss	Impedance	Distance to switch/ cable loss/ terminating switch
ShortCO	0 dB	3 dB	Short	Short/<2 dB/ICS to CO
Medium-CO	0 dB	0 dB	TIA/EIA 464	Medium/>2 dB and <6 dB/ICS to CO
LongCO	-3 dB	0 dB	TIA/EIA 464	Long/>6 dB/ICS to CO
ShortP-BX	0 dB	0 dB	Short	Short/<2 dB/ICS to PBX
LongPBX	-3 dB	0 dB	TIA/EIA 464	Long/>2 dB/ICS to PBX

A loss of 4 dB corresponds to a cable length of approx. 2700 m (9000 ft.).

Press **CHANGE** to select the setting: ShortCO, **MediumCO**, LongCO, ShortPBX or LongPBX.



**Tip** - *This setting applies only to lines connected to a Global Analog Trunk Cartridge (GATC) with LS/DS (or LS/DS Analog Trunk Cartridge). It does not apply to a GATC with CLID Trunk Cartridge.*

*When measuring the distance from ICS to CO and from ICS to PBX, use 600 ohms as the termination resistance setting.*

## Rec'd #



Installer password required

The Received number setting applies only to target lines (line numbers 061 to 086). It allows you to specify the digits which make a specific target line ring. The default value is **None**.

Use **CHANGE**, and the dialpad to program the digit string for each target line.



**Tip** - A Received number can be two to seven digits long (programmed in **SYSTEM PROGRAM**). The default length is 2.

A received number cannot be the same as, or be the start digits of a line pool access code, a destination code, the DISA DN or the Auto DN.

*If you are configuring auto-answer BRI trunks to map to target lines, the received number should be the same as the Network DN supplied by your service provider. The call will be directed to the prime telephone for the incoming line if the Network DN is not used.*

## If busy

Target lines can be programmed to give a busy tone if all sets with appearances of the target line are engaged. Busy tone only works for BRI trunks. You can change this default setting to transfer the call to the Prime set. Programming is done in **Line data** under **Lines**. Press **CHANGE** to select the setting: **To prime** or **BusyTone**.

## Distinctive ring

You can program one of four levels of distinctive ring patterns (DRP) to lines (None, 2, 3, 4). The higher the DRP, the higher the priority calls have when they come in on that line. This feature works in conjunction with ring patterns set on individual telephones and for Hunt groups.

## Name

The default name for a line is 'Line' and its three-digit number (for example, Line001), but it can be changed to any combination of letters and numbers to a maximum length of seven characters.

For more information see the *Compact ICS 6.0 System Coordinator Guide*.

## Restrictions

Preventing a user from using a line for making certain kinds of calls is done in Restrictions. For example, users should not be able to make long-distance calls on lines used exclusively for local calling.

## Restrnr filters

A restriction filter is a set or group of restrictions and overrides that specify the external numbers or feature codes that cannot be dialed from a telephone or on a line. Rather than define individual restrictions and apply them repeatedly to telephones and to lines, restriction filters let you assign them in one step as a single package of dialing sequences that are not permitted.

You can make changes to restriction filters under both Terminals&Sets, and Lines. Any changes will take effect for any telephone, line or line on a telephone regardless of where the programming was changed.

See the description and procedures for restriction filters under Terminals&Sets in this guide on page 136 for more information.

## Line restrns



Installer password required

Specify the filter to be applied to this line to restrict the numbers that can be dialed on it. You can assign a different restriction filter for normal service and for each of six schedules. See the section on Services for more information about the schedules.

Use  , **CHANGE** and the dialpad to enter the number of the restriction filter to be assigned as the line restriction for each schedule. The default restrictions are as follows:

### Default filters for lines

Schedule	Restriction filter
Normal	03
Schedule 1 (Night)	21
Schedule 2 (Evening)	22
Schedule 3 (Lunch)	23
Schedule 4	00
Schedule 5	00
Schedule 6	00



**Tip** - *When a remote user places an external call on a line, any filters used with the line still apply.*



Installer password required

## Remote restrns

Specify the restriction filter to be applied to remote callers calling in to the Norstar system on this line. A restriction filter is a set or group of restrictions and overrides.

As with line restrictions, you can apply a different remote restriction for normal service and for each of six schedules.

Use **CHANGE** and the dialpad to program the remote restrictions for each schedule. The default restrictions are as follows:

### Default filters for remote access

Schedule	Restriction filter
Normal	04
Schedule 1 (Night)	31
Schedule 2 (Evening)	32
Schedule 3 (Lunch)	33
Schedule 4	00
Schedule 5	00
Schedule 6	00



**Tip** - *The remote restriction restricts the numbers that can be dialed on an incoming auto-answer line. If a remote user then selects a line to place an external call, any filter used with the line still applies.*

## Telco features



Installer password required

### VMsg center 1

If you subscribe to a voice message service, you can specify which voice message center is used for each external line that can receive message waiting indication. For each line, press CHANGE to select the setting: 1, 2, 3, 4, 5, or N (None).

You enter the telephone numbers for each of the five voice message centers under the general Telco features heading.

# Services

Using Services, you can control three types of service by the time of day and day of week:

- alternate call ringing for certain times and days
- alternate dialing restrictions for certain times and days
- alternate call routing for certain times and days

Each of the three services has six schedules that you can customize. For example, you may want to combine alternate call ringing with alternate dialing restrictions for lunchtime, evenings, and weekends (Schedules 1, 2, and 3). Then you may want to run alternate call routing using three separate schedules.



**Tip** - *Once you have programmed the different services and schedules, you can turn each of the services on separately. For example, the Night schedule might control both Ringing service and Restriction service. But you can turn on just the Ringing service part of the Night schedule if you wish.*

*You can activate the services from the designated control telephone for each Norstar telephone and line in your system. You can have one control telephone for the whole system, or different control telephones for different Norstar telephones and lines.*

*If you want to have several services active at the same time, simply program them on for the same schedule.*

## Ringing service



Installer password required

At certain times or in certain situations, you may want additional telephones to begin ringing for incoming lines. The most common use of this feature is when a security desk telephone begins to ring for incoming lines after 5:00 p.m., a practice often called night service. These features are programmed under Ringing service.



## Ring Groups

Ring groups allows you to define groups of extended ringing sets. A group can be assigned to any line for any of the schedules. You can create up to 100 ring groups.

To define a ring group, use  and enter the number of the group you want to program (01-100).

Once you define a ring group, the display will prompt you to enter the number of the set you want to assign to this ring group. You can use **SCAN** to display the sets that are assigned to the ring group.



**Tip** - You can assign any set on the Norstar system (up to 24 sets) to a ring group. The assigned control set for each schedule is added to each ring group.

*A set can belong to more than one ring group.*

## Night sched

Indicate how Ringing service should be activated for each of the schedules.

### Service

Use , , and **CHANGE** to change the setting for each schedule: **Off**, Automatic, or Manual.

Manual allows you to turn the service on and off at any time from a control telephone using the Ringing service feature code.

Automatic allows you to program a stop and start time for a service. You are still able to start and stop the service by entering the appropriate Services feature code at a control telephone. If you select this setting, you will have to set start and stop times. See *Schedule times* on page 186 for information on programming times.

Off prevents the service from being activated.

## Trunk answer

Trunk answer allows you to answer, from any telephone, an external call that is ringing at another telephone in your office. This is useful if the other telephones have not been assigned the same lines as the telephone you are using to answer the call.

Press CHANGE to select the setting: **Y** (Yes) or **N** (No).



**Tip** - *You can change the Trunk Answer setting only if Ringing service is set to Manual or Automatic.*

## ExtraDial telephone

ExtraDial telephone allows you to assign an additional direct-dial telephone in the Norstar system for each schedule you use.

Use CHANGE and the dialpad to enter the internal number of the extra-dial telephone.



**Tip** - *The extra-dial telephone is activated during a schedule by entering the Ringing service feature code from a direct-dial telephone. This does not activate the Ringing service unless the direct-dial telephone is also a control telephone.*

## Line settings

The ring groups and auxiliary ringer use for Ringing service is programmed for each line individually.

## Ring group

You can assign a pre-defined ring group to a line for each schedule. See Ring groups in this section to create groups of extra ringing telephones.

Using the dialpad, enter the line number to see which ring group is assigned to the line. Press **CHANGE** and the ring group number (01-20) to choose a different ring group assignment.



**Tip** - *Only one ring group can be assigned to a line for each schedule. To combine groups of ringing sets, you must create a new ring group which contains all the sets you want to ring and assign it to the line.*

## Aux. ringer

Indicate whether the auxiliary ringer (if installed) also rings when Ringing service is on. Press **CHANGE** to select the setting: **Y** (Yes) or **N** (No).



**Tip** - *The default ringing telephone is 21. This means that all lines ring at telephone 21 when Ringing service is on.*

*You can use **COPY** and the dialpad to copy Ringing set and Auxiliary ringer programming from one line to another.*

*If you have an auxiliary ringer programmed to ring for calls on an external line, and you transfer a call on that line without announcing the transfer, the auxiliary ringer will ring for the call transfer.*

## Restrtn service



Installer password required

Indicate how the alternate dialing restrictions should be activated for each of the schedules.

Use  ,  , and **CHANGE** to change the setting for each schedule: **Off**, Automatic, or Manual.

See Ringing service in this section for descriptions of the three settings.

See Restrictions under both Terminals&Sets and Lines to assign dialing restrictions for telephones, lines and remote users to the schedules.

## Routing service



Installer password required

The programming for routing service decides what path an outgoing call takes using the digits that are dialed. It is sometimes called automatic route selection (ARS).

When you select an internal line and dial, the numbers you enter are checked against the routing tables. If the number you dialed starts with a destination code, the system uses the line pool and dials out digits specified by the route assigned to that destination code, and then dials the number that you dialed.

Routing service replaces a number of tasks that otherwise have to be done manually, including:

- entering a line pool code
- dialing an access code for a long distance carrier
- deciding which line pool to use according to the time and day

The installer can set up routing to take advantage of any leased or discounted routes using information supplied by the customer. The system itself cannot tell which lines are cheaper to use.

Using routing to create a transparent dialing plan or coordinated dialing plan is explained in *Networking with Norstar* on page 41.



**Tip** - The numbers used for destination codes must not conflict with the first digit in:

- Call Park prefix
- External access code
- direct-dial number
- Line pool code
- internal extension numbers (DNs)
- DISA extension numbers
- Auto DN

*For example, the system will not allow you to enter a destination code that starts with 2 if your internal number system starts with 221. But an internal number of 221 and a destination code of 321 would work.*

*A table of the initial digits used by default for all these features is included in the section on Access codes programming.*



***Plan your routing service before doing any programming.***

Routing affects every call placed in the system and must be carefully planned to avoid conflicts and gaps in the programming. Use the tables in the *Compact ICS 6.0 Programming Record* to design routes and destination codes, then check for potential problems before you start programming. It will also save you time to have all the settings written out in front of you.

## Routes



Installer password required

Press  and enter a three-digit route number (000-999).

## DialOut

Press  and enter the DialOut digits (up to 24), or press CLR to choose **No numbr.**

You can press    to insert a 1.5-second pause in the dialing string, if necessary.

Route 000 has no DialOut by default and cannot be changed.

## Use Pool

Press  and CHANGE to select a line pool to be used with the route: **Pool A**, Pool B, Pool C.

Route 000 uses Pool A by default and cannot be changed.

## Dest codes



Installer password required

Enter a destination code that will be recognized when used as part of a telephone number for an outgoing call. It can be up to seven digits long.



**Tip** - Press CLR and ADD to change the digits for an existing destination code.

## Wild card character

When programming destination codes, you can use wild cards as the last number in a destination code string. By using wild cards, you can reduce the number of destination codes programmed in the system, maximizing the distribution of destination codes in the system.

The wild card character is added to the destination code by pressing the **ANY** key as the last digit of the code. This character represents any digit from 0 to 9, except for digits already programmed or used by other numbering plans. Should there be a conflict with other digits already programmed or used by numbering plans, the digit will not be displayed.

The wild card character can only be used to group destination codes that use the same Route and Absorb Length.

Given the routes shown in the table below, the next two tables show you how to set up destination codes with or without wild card characters.

Route	DialOut	Line Pool
555	0162 237 625	Line Pool C
565	0173 133 2211	Line Pool A

### Destination codes without using a wild card character

Destination codes	Route	Absorb Length	DialOut
0621	555	3	0162 237 6251
0622	555	3	0162 237 6252
0623	555	3	0162 237 6253
0624	555	3	0162 237 6254
0625	555	3	0162 237 6255
0626	555	3	0162 237 6256
0627	565	All	0173 133 2211
0628	555	3	0162 237 6258
0629	555	3	0162 237 6259

**Destination codes using a wild card character**

Destination codes	Route	Absorb Length	DialOut
062 •	555	3	0162 237 625X where X is the final dialout digit, from 1 to 9, but not 7
0627	565	All	0173 133 2211

**Normal rte**

Select which route a call using the destination code takes during normal service and for each of the schedules. The automatic schedule times are programmed under Services. The default Normal route is **000**, which has no DialOut digits and uses Pool A.

**AbsorbLength** (digit absorption)

Select the portion of the destination code that is always absorbed by the system and not used in the dialing sequence. Press **CHANGE** to select the number of digits to be deleted: 0, 1, 2, 3, 4, 5, 6, or **All**.



**Tip** - *To dial a telephone number which does not match any of the programmed destination codes, the user will have to choose a line and dial the number. For long distance dialing to be consistent, all area codes in the North American numbering plan should be programmed as destination codes.*

**Routing table modifications.**

Changes to the routing tables should only be made during least busy call times or on an idle system. Plan to program the routing tables when user activity is at a minimum.



## Setting up a route for local calling

An office may have different line pools for local and long distance telephone service. By programming a destination code, any call that begins with 9, the most common digit for dialing out, will automatically use lines dedicated to local service. This example assumes the lines used for local service are in Pool A.

Destination codes cannot conflict with any other digits users may dial as part of a internal or external call. Because 9 is the default digit for external line access, it may have to be changed under **Access codes** before 9 will be available for use as a destination code. Because a system using two-digit DNs uses up all the leading digits as access codes, the examples in this section assume that the internal directory numbers are at least three digits long.

The first step is to build a route (under **Routing service** in **Services**).

- enter 000 (a default route that gives you no DialOut and uses Pool A) at **Show Route:**.

Press **SCAN** to view defined routes.

- enter the DialOut digits (if any) which are needed to direct the call once it is connected to an external line. In this case, no digits are needed.
- assuming that the lines for local calling have been placed in Line pool A, choose it as the line pool. This is already done because you are using Route 000, which always uses Pool A.

The second step of programming is setting up how the route will work with a destination code. Because users will dial 9 to make an external call, 9 should be the destination code.

- press **ADD** at **Show DstCode:**.

To view existing destination codes press .

- enter 9 as a new destination code
- press .
- press **CHANGE** and enter the number of the route that should be used for a call starting with 9. In this example, it is route 000 (the default route).

- press `Show` and choose how many digits should be removed from the dialing sequence before it reaches an external line. In this example, set it to 1.

The initial digit 9 is only significant to the Norstar system and should be absorbed in order for the call to proceed successfully in the external telephone network.

The destination code can use a different route depending on the schedule (see the beginning of the Services section and sections on schedules for more information). In the current example, Route 000 is used when someone dials 9 during normal service, but you may want to create another route to be used with the Night schedule.

- press `Next` at `Normal rte:` to see and change the routes used with this destination code when different schedules are in use.

## Setting up a route for long distance calling

An office may have leased lines which make it cheaper to call long distance. The routing should take place automatically when the number of the outgoing call begins with 1.

Destination codes cannot conflict with any other digits users may dial as part of a internal or external call. Because 9 is the default digit for external line access and 1 is the default digit for the Call Park prefix, they may have to be changed under `Access codes` before 9 and 1 will be available for use as destination codes.

Again, the first step is to define a route (under `Routing service` in `Services`).

- enter 002 (or any other available route number) at `Show Route:`
- enter the DialOut digits (if any) which are needed to direct the call once it is connected to an external line. For this example, no digits are needed.
- assuming that the lines for calling long distance have been placed in Line pool B, choose it as the line pool
- press `ADD` at `Show DstCode:`
- enter 1 as the new destination code

- press . The route for normal service appears after **Normal rte:**. Press **CHANGE** and enter the defined route number 002.

In this example, the system uses Route 002 (which uses Line pool B) to take advantage of the lower cost when the system is in normal service.

In the example, the 1 in the destination code is also needed to direct the call in the public network. It should not be absorbed in the routing process.

- press  at **AbsorbLength:**. Press **CHANGE** until **0** appears.

The following tables from a sample Programming Record show these routes for local and long distance calling.

<b>Routing Service</b> (Services: Routing Service)		
Route #	DialOut	Use Pool
000	Route 000: no DialOut/uses Pool A; cannot change	A B C
002	none	A <b>B</b> C
		A B C
		A B C
		A B C

<b>Routing service (continued)</b>								
Dest code (Services: Routing service:Dest codes)								
Service name	Normal		Night Rte		Evening		Lunch	
	Use route (000-999)	Absorb Length	Use route (000-999)	Absorb Length	Use route (000-999)	Absorb Length	Use route (000-999)	Absorb Length
9	<del>000</del> 000	All		All		All		All
1	<del>000</del> 002	All 0		All		All		All
	000	All		All		All		All
	<del>000</del>	All		All		All		All



**Tip** - *If rates change depending on the time of the day or week, a different route can be used for the same destination code 1 when a particular schedule is in use. See 'Programming for least cost routing.'*

## Adding a long distance carrier access code

In many cases, long distance service uses the same lines as local service but is switched to a specific carrier using an access number, which is sometimes called an equal access code. Programming for routing can include the access number so users do not have to dial it every time they make a long distance call.

To make this type of dialing possible, set up the following:

- create a route that uses the access number as the DialOut digits
- program the route to use a line pool containing the lines used to access the long distance carrier
- create a destination code 91: 9 (for outside access) and 1 (for long distance)
- set the AbsorbLength to 1: the 9 is used internally and should be dropped; the 1 is needed to direct the call.



**Tip** - *The destination codes 9 and 91 used in the examples cannot be used together. If the destination code 91 is needed to direct long distance calls, you must create a separate set of codes that use local calling routes. These codes would be, for example, 90, 92, 93, 94, 95, 96, 97, 98 and 99. See Wild card character on page 175 for information on programming destination codes.*

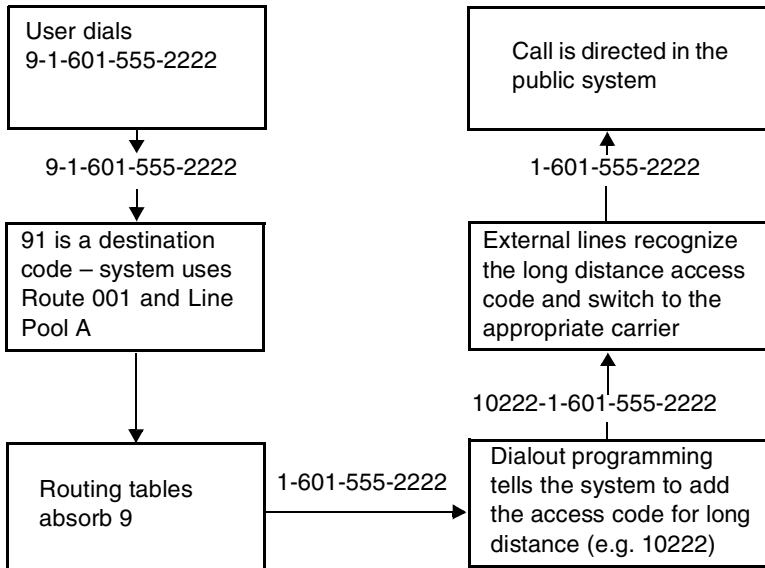

## Programming for least cost routing

It may be cheaper to use another long distance carrier at another time of day. Continuing with the example used in the flowchart, long distance calls will go out on the same lines without an access code at Night because that is when rates become competitive. For the system to do this automatically, another route has to be built.

- choose Route 007 (or any other available route) at **Show Route:**
- press **CLR** to choose **No number** for the DialOut
- choose Line pool A (local service carrier lines)

In this case, the change in route uses the start and stop times for the Night schedule (the schedules are set up under Services programming).

- enter 91 at **Show DstCode:**
- make sure **AbsorbLength** is set to 1
- the route programmed with the access code as its DialOut (Route 001) remains as the route used by **Normal rte:**
- under **Night rte:**, select Route 007

Calls that begin with the digits 91 will now travel out without using the access code when the Night schedule comes into use automatically, or when it is turned on at a control telephone.

## Night sched



Installer password required

Indicate how the alternate routing should be activated for each of the schedules.

### Service

Use  ,  , and **CHANGE** to change the setting for each schedule: **Off**, **Automatic**, or **Manual**.

See Ringing service in this section for descriptions of the three settings.

### Overflow routing

If all the lines used by a route are busy when a call is made, each schedule may be programmed to overflow to the route used for normal service. If this happens, the set will sound a warning tone and display the message **Expensive route**. The caller can then release the call to avoid using the normal route, or continue with the call.

Overflow routing is turned on or off for each schedule in programming. Press **CHANGE** to select the setting: **Y** (Yes) or **N** (No).



**Tip** - *A schedule must be in use for overflow routing to be active. Overflow routing is not available in normal service.*

*You must create an overflow route to be used with each destination code. This means every route used with a schedule that has overflow service must have an alternate in normal service.*

## Using dialing restrictions with routing

Routing service can be further customized by adding dialing restrictions to lines in line pools. Filters can restrict the use of the line to specific area codes. See the Networking features section of the *Networking with Norstar* on page 41, and Restrictions under both the Terminals&Sets and Lines programming sections for more information.



**Tip** - Host system signaling codes shown in the table can be part of the DialOut for a route

You can also use routing as an alternate method for a direct-dial number. For example, create a destination code 0 and program the number of the internal or external destination as the DialOut. Digit absorption should be set to 1.

*Because overflow routing directs calls using alternate line pools, a call may be affected by different line restrictions when it is handled by overflow routing.*

### Host system signaling codes

 7 1

Link – if your Norstar system is connected to a private branch exchange (PBX), you can use a Link signal to access special features.

 7 8

Pause – Enters a 1.5-second delay in a dialing sequence on an external line.

 \* 8 9

Programmed Release – performs same function as  in a programmed dialing sequence. When the system encounters Programmed Release in a dialing sequence, it stops dialing and hangs up the call

 \* 9

Run/Stop – inserts a break point into a sequence of dialed numbers or characters used for automatic dialing.

 8 0 4

Wait for Dial Tone – causes a sequence of numbers to pause until dial tone is present on the line before continuing to dial.

See the *Compact ICS 6.0 System Coordinator Guide* for more information.

## Common settings

Services share the settings for control telephones, schedule names and schedule times.

### Control sets

A control telephone turns Services on and off for the lines and/or telephones assigned to it.

You can assign several control telephones for your system.

- A control telephone for lines controls Ringing service, Restriction service and Routing service for its assigned lines.
- A control telephone with assigned telephones controls Restriction service and Routing service for its assigned telephones.

Assign a control telephone for each external line and telephone.

Use  , **CHANGE**,  , and the dialpad to program the internal number of the control telephone for each line and each telephone.

Control set configurations for both lines and telephones can be copied from one set/line to another set/line or to a range of sets/lines, or to all sets/lines, using the COPY softkey.



**Tip** - *External lines and telephones must be programmed with a control telephone to use the three kinds of Services.*

*You can copy the settings for a control telephone to more than one external line or telephone, but a line or telephone cannot be assigned to more than one control telephone.*

*One recommendation is to have one control telephone for all lines and a different control telephone for all telephones.*



*A service can be turned on manually or automatically for all external lines and telephones controlled by a given control telephone, but you cannot combine schedules. In other words, a service can only be active as normal service or one of the six schedules at any one time. You can have several schedules active, as long as they are using different services.*

*The default control telephone for all lines and telephones is 21.*

## Schedules names

The schedule name is shown on the display of the control telephone when the schedule is turned on. It identifies the active schedule.

Use  , **CHANGE**,  , and the dialpad to program the name.



**Tip** - *The default names of the six possible schedules are only suggestions and may be changed to any other name.*

*A schedule name can be one to seven characters long.*

*It is recommended that you reserve certain schedules (4, 5, and 6) exclusively for alternate call routing (Routing service).*

## Schedule times

Schedule start and stop times are set at times you are most likely to want each service to be active. Use  , **CHANGE**,  , and the dialpad to program the start and stop times for each schedule, on each day.

### Default schedule times

Schedule	Start time	Stop time
Schedule 1: Night	23:00	07:00
Schedule 2: Evening	17:00	23:00
Schedule 3: Lunch	12:00	13:00
Schedule 4: Sched 4	00:00	00:00
Schedule 5: Sched 5	00:00	00:00
Schedule 6: Sched 6	00:00	00:00

You can copy schedule times using **COPY** to make the programming easier. The following example shows how to program Night Schedule to start at 5:00 p.m. on Monday through Friday, and end at 8:00 a.m. the following weekday morning. Night Schedule stays on all day Saturday and Sunday.

1. Enter 5:00 p.m. as the start time and 8:00 a.m. as the stop time for Monday under the Night Schedule.
2. Use **COPY** to program the same settings to Tuesday, Wednesday, Thursday, and Friday.
3. Enter 8:00 a.m. as the start time and 8:00 a.m. as the stop time for Saturday under the Night Schedule.



**Tip** - *It is only necessary to program start and stop times for schedules that are activated automatically. See the instructions with Ringing service for information on activating schedules.*

*The time may be entered in either 12 or 24-hour format. If the display is in English, and the hour entered is less than 13, the display prompts you to specify AM or PM.*





---

# Sys speed dial

---

System speed dial allows you to create speed dial codes that can be used by any telephone in the system.

For CICs version 6.0 the number of system speed dial codes has been increased to 200 (001 to 255). The user speed dial codes have been adjusted to the 256-279 range.

If you specify a name with the speed dial entry, an incoming call on a CLID line with a dialed number that matches the speed dial entry will display the name as part of the CLID display on the receiving telephone or when     is invoked to display call information. This method of using the system speed dial entries for CLID display is called Alpha tagging.

**Note:** Alpha tagging is only invoked when the CO line service does not supply a name for the incoming call. It will only occur on telephones that have Caller ID set turned on (*Caller ID set on page 152*).

The CLID Match setting (*CLID Match on page 210*) determines how many digits of the received number need to match the system speed dial number to be accepted as a CLID match to allow the name display to occur.

For more information on using and programming System speed dial, see the *Compact ICS 6.0 System Coordinator Guide*.

---

# Passwords

---

## COS pswds

Class of Service (COS) passwords permit controlled access to system resources by both internal and remote users. When you enter a Class of Service password at a telephone, the restriction filters associated with your Class of Service password apply instead of the normal restriction filters. Similarly, when a remote user enters a Class of Service password on an incoming auto-answer line, the restriction filters and remote package associated with their Class of Service password apply instead of the normal restriction filters and remote package.

COS passwords allow you to define individual passwords and determine the restriction filters and remote package associated with each.



**Tips** - *Class of Service passwords for a system should be determined randomly and should be changed on a regular basis.*

*Users should memorize their COS passwords instead of writing them down.*

*COS passwords should be deleted when the employee they are assigned to leaves the company.*

*Typically, each user has a separate password. Alternately, several users can share a password or one user can have several passwords.*

*A system can have a maximum of 100 six-digit COS passwords (00 to 99).*

*You can use COPY and the dialpad to copy the restriction filters and remote package from one COS password to another. COS passwords must be unique.*

---

## Pswd

Pswd defines the six-digit Class of Service password. There is no default password.

Use  , **CHANGE**, and the dialpad to program the six-digit password. Use **EXSP** to edit numbers you have entered.

## User flt

User filter allows you to assign a restriction filter to a Class of Service password. The user filter associated with the Class of Service password replaces any normally applicable set restriction, line/set restriction, and remote restriction.

Use  , **CHANGE**, and the dialpad to program the two-digit user filter. The default setting (**None**), means that any normally applicable filters (set restriction, line/set restriction, or remote restriction) still apply.

## Line flt

Line filter allows you to assign a specific line restriction to a Class of Service password. The line filter associated with the Class of Service password replaces any normally applicable line restriction.

Use **CHANGE** and the dialpad to program the two-digit line filter. The default setting (**None**), means that any normally applicable line filter still applies.

## Remote pkg

Remote pkg allows you to assign a specific remote access package to a Class of Service password. The remote access package associated with the Class of Service password replaces any normally applicable remote access package.

Use **CHANGE** and the dialpad to program the two-digit remote package. The default setting (**None**), means that any normally applicable remote access package still applies.

## Call log pswds

This setting allows you to override any Call log password programmed with the Call log feature, and resets it to **None**. It is used when someone forgets a password. Press  and enter the DN of the telephone. Press  and then **CLR** to clear the programmed password.



**Tip** - You program a Call log password using the Call log Password feature. See the Telephone Feature Card or the Compact ICS 6.0 System Coordinator Guide for more information.

## Programming pswds

You can choose any combination of six digits for Passwords. It is easier to remember the password if the digits spell a word.

Provide passwords only to selected personnel to prevent unauthorized access to programming. Some passwords allow line assignments to be rearranged, which could disrupt your telephone service.

## Installer

The default Installer password is **266344 (CONFIG)**.

Use **CHANGE**, the dialpad, and **OK** to program the Installer password.

Record the password in the *Programming Record*.

## SysCoord+

The default System Coordinator Plus password is **727587 (SCPLUS)**.

Use **CHANGE**, the dialpad, and **OK** to program the System Coordinator Plus password.



**Tip** - An overview of what programming is available by using the System Coordinator Plus password is on page 116.

## SysCoord

The default System Coordinator password is **23646 (ADMIN)**.

## Basic

The default Basic password is **22742 (BASIC)**.



**Tip** - For more information about the System Coordinator and Basic passwords, see the *Compact ICS 6.0 System Coordinator Guide*.

## IRAD pswd

The ability to do remote programming using the internal remote access device (I-RAD) is protected by a password. If your Feature Cartridge does come with the I-RAD enabled, the feature is not available until you enter Software Keys provided by Nortel.

Use **CHANGE**, the dialpad, and **OK** to change the I-RAD password. Currently, the remote administration software used with the I-RAD allows you to use a password up to 10 digits long. A longer password will not work with the software. The default password is the eight-digit Sys ID number.

Your I-RAD password should always match the password used with your remote administration software.

The I-RAD password returns to the default value when you upgrade the system software from CICS 1.0 or 2.0 to CICS 6.0.

## Hospitality password

There are two passwords within the hospitality feature. One provides secure access to the administration set, and one provides secure access to a room condition setting from each room set for housekeeping staff.

### Desk pswd

Change this password frequently, to maintain security.

At Hospitality:

1. Press .
2. **Desk Pswd:4677** displays.
3. Press **CHANGE**.
4. **New Pswd:** displays
5. Enter a new password, then press **OK**.

### Cond pswd

Change this password frequently, to maintain security.

At Hospitality:

1. Press .
2. Press .
3. **Cond Pswd:None** displays.
4. Press **CHANGE**.
5. **New Pswd:** displays
6. Enter a new password, then press **OK**.



---

# Time&Date

---

The time and date shown on the telephone display is used by the system for scheduled features. It can be changed in programming or by using a feature code (        or        ).

For more information, see the *Compact ICS 6.0 System Coordinator Guide*.

# System prgming

---

System prgming allows you to set up features and settings which are not associated with any specific line or telephone.

## Hunt groups

The hunt groups feature allows a group of sets to be called by a single directory number ensuring that calls are easily routed to the appropriate group.



**Tip** - *If you want to use Hunt groups, your system must have a minimum of three-digit DNs.*

The default setting for hunt groups is broadcast mode. Sequential or rotary modes are also available.

Hunt groups can be used to route calls to a support service such as a Help Line for a software company. Specialists dealing with Product A can be in one group, and specialists dealing with Product B can be in another group. Incoming calls will hunt for the next available set in the group. If no set is available, the call can be placed in a queue or routed to an overflow set.

The Hunt groups subheading in system programming is the area that programming changes are made to the following:

- members of a group
- member position in a group
- what lines are assigned to a group
- how incoming calls are distributed
- how long the system looks for available agents
- where a call goes if all agents are busy
- distinctive ring pattern for a Hunt group

The hunt group setting impacts other features:

- Call forwards set on telephones that are members of a hunt group are overridden by the hunt group routing.
- Sets that are members of a hunt group can temporarily leave a group by activating the DND feature.
- Priority calls to a hunt group will be rejected
- Hunt group set numbers cannot be in a ring group.
- Hunt group set numbers cannot be in a page zone.

**Note:** Fixed external cadencing is provided for all external hunt group calls regardless of whether or not they have been answered and transferred.

**Note:** Videophones should not be programmed as members of a hunt group. Hunt groups allow one B channel connection at a time and videophones use two B channels.

## Adding or removing members from a group

Members of the group can be any Norstar set, CTA 500dm, or ISDN set. A set can be in more than one hunt group but is considered a member in each hunt group, increasing the total number of members in the system.

There can be only one appearance of the same hunt group on a set. The appearance can be one of three types: Appr&Ring, Appr only, or Ring only.

The set number range for hunt groups is based on your start DN. You can find the range in **Hunt Groups** under **System Prgming**. These DNs cannot be assigned to telephones.

Hunt groups can be programmed under System prgming.

1. Press . The display shows **Hunt Groups**.
2. Press . The display shows **Show Group#:**
3. Enter the hunt group number you want to program (1-6).
4. Press . The display shows **Member extns#:**
5. Press . The display shows the members for that group.

6. Press **ADD** to add a member or press **REMOVE** to remove a member from the group.
7. Select Appr&Ring, Appr only or Ring only setting for hunt group member. See *Line assignment on page 137*.

## Moving members of a group

Member order within a hunt group is important. Calls are routed starting with the first member, except in Broadcast mode, when calls are sent simultaneously to all members.

1. Press **MOVE** to move an existing member to another place within the hunt group. The display shows the member number followed by an arrow.
2. Enter the new position number for the set.

## Assigning or unassigning lines to a group

Set hunt group line Prime set to None. This avoids delayed ring transfer of external hunt group calls to the Prime set before the hunt group can receive the call.

A line can only be assigned to one group.

1. When the display shows **Member sets:**.
2. Press . The display shows **Line assignment**.
3. Press . The display shows **Show line:**.
4. Enter the line number you want to program, press **SCAN** to go the first line assigned to this group or press **LIST** to go to the first line in the system.
5. Press **CHANGE** to program the line as **Unassigned** or Assigned.

**\*HGnn\*** means the line is assigned to another hunt group.

## Assigning a distinctive ring pattern to a Hunt Group

You can assign distinctive ring patterns to your Hunt Group so that calls can be rated in priority for the group.

These distinctive ring patterns, have the same characteristics as for line and extension distinctive ring patterns. Refer to *Distinctive ring on page 163*.

The Hunt Group distinctive ring pattern determines how a call will ring within the Hunt Group. If members of the group have ring patterns assigned to their telephones that are higher than the ring patterns of the incoming line or the Hunt Group, then the Hunt Group will use the ring of the corresponding member telephones.

If the incoming call (line) has a higher ring pattern assigned than the Hunt Group, the Hunt Group will ring with the line ring pattern.

1. Find the heading **Hunt Groups**.
2. Press  until the display shows **Member extns:**.
3. Press  until the display shows **Distnct Ring: NONE**.
4. Press **CHANGE** to toggle to the ring pattern number you want to assign to the Hunt group line. (**None, 2, 3, 4**)
5. Press  to exit or  to continue programming.

## Setting the distribution mode

There are three modes of call distribution:

- **Broadcast**—rings each set in the group simultaneously. Calls are handled one at a time, other calls are queued. As soon as a call is picked up, the call next in the queue is presented to the hunt group without having to wait for queue timeout.  
In Broadcast mode, a single incoming call will ring simultaneously at all the sets in a group. This way, all receptionists in the group can share the load of answering large volumes of calls. A familiar example is a fund-raising campaign where a group of operators would be waiting to take each call as it comes in.

- **Sequential**—starts the call at the first set in the hunt group and distribution is complete when the first free set has been found. Simultaneous calls can be presented. Distribution is order based. In Sequential mode, you can program your top salesperson to be the first member of the group to receive incoming calls.
  - **Rotary**—the call starts at the set after the one which was last presented and distribution is complete when the next free set has been found. Simultaneous calls can be presented. Distribution is order based. In Rotary mode, you can ensure that all your help-line people are receiving calls, rather than one person receiving the majority of calls.
1. When the display shows **Member extns.:**
  2. Press  until the display shows **Mode.:**
  3. Press **CHANGE** to set the mode: **Broadcast**, Sequential, Rotary.

If a hunt group has available agents but nobody answers the call, the call is routed according to what is set in the Busy line setting. Refer to *Programming busy line setting on page 198*.

## Setting the hunt delay

This setting allows you to program the number of rings the system permits at a hunt group set before moving on to the next set in the hunt group. This display only shows if the distribution mode is sequential or rotary.

1. When the display shows **Member extns.:**
2. Press  until the display shows **Hunt delay.:**
3. Press **CHANGE** to select the setting: 1, 2, 3, **4**, 5, 6, 7, 8, 9,10.

## Programming busy line setting

There are three routing options if all agents are busy:

- **BusyTone**—the caller gets a busy tone for BRI, otherwise the telephone rings back
- **Overflow**—the call is routed to an overflow position. You can not use overflow if the overflow DN is a hunt group DN.
- **Queue**—the call stays in the system for a period of time. Within this period of time, the call will be presented to an agent if one becomes

---

available. When the time-out occurs, the call will be presented to an overflow position.

1. When the display shows **Member DNs:**.
2. Press  until the display shows **If busy:**.
3. Press **CHANGE** to set the mode: **BusyTone**, **Overflow**, **Queue**.

## Programming the queue timeout

This setting allows you to program the number of seconds a call will remain in the hunt group queue before it is routed to the overflow position.

1. When the display shows **Member DNs:**.
2. Press  until the display shows **Q Timeout:**.
3. Press **CHANGE** to set the queue timeout: 15, 30, 45, **60**, 120 or 180.

## Programming the overflow set

This setting allows you to program the over flow set the hunt group calls will be routed to. Unless the overflow position is a hunt group set, the call ceases to be a hunt group call. If the overflow set is a hunt group set, the call is treated as a new call and goes to the bottom of the queue.

The overflow set can be a set number associated with a voice mailbox.

1. When the display shows **Member DNs:**.
2. Press  until the display shows **Overflow:**.
3. Press . The display shows **Overflow:HGr.**
4. Press **CHANGE** to change the overflow position.
5. Enter the new overflow position.

## Setting the function name

This setting allows you to program the hunt group function name, such as SERVICE or SALES. The name can be up to seven characters in length.

1. When the display shows **Member DNs:**.
2. Press  until the display shows **Name:**.
3. Press **CHANGE**.
4. Using the dialpad, enter the name of the hunt group.
5. Press  to store the name.

## Change DNs



Change DNs allows you to change the directory number (DN) or internal number of a telephone.



### ***Changing DN locks programming session***

Changing an individual DN locks the programming session into the Change DNs programming mode. After you have finished and have pressed , re-enter the programming access code and the Installer password to continue with other programming.

Do not perform Startup again or all previous programming will be erased.



Use  and the dialpad to identify the DN you want to change (old DN). Use the dialpad to enter the new DN.



**Tip** - *No DN changes occur until the programming session ends.*

*If the new DN already exists for another telephone, that other telephone is given the old DN.*

*All DNs must be the same length.*

*The first digit of a new DN cannot be the same as the first digit of:*

- *an external line access code*
- *a line pool access code*
- *the Park prefix*
- *the direct-dial digit.*

*To avoid a conflict, refer to the table of default settings provided under Access codes. The lowest default DN is 21.*

## Featr settings

### Backgrnd music

Background music allows you to listen to music through your telephone speaker. A music source must be connected to the ICS. Press **CHANGE** to select the setting: **N (No)** or **Y (Yes)**.

### On hold

On hold allows you to choose what a caller hears on an external line when the line has been put on hold. Press **CHANGE** to select the setting: **Tones**, **Music**, or **Silence**.

- Tones provides a periodic tone.
- Music provides any signal from a source such as a radio connected to the ICS.
- Silence provides no audio feedback.

## Handset volume

Handset volume allows you to specify whether the volume level of a handset or headset will return to the system default level when a call is ended or put on hold, or whether it will remain at the level set at the individual telephone.

Use  and CHANGE to select the setting: **Use sys volume** or Use set volume.



**Tip** - *This feature is not available on some older telephones.*

## Camp timeout

Camp timeout delay allows you to assign the number of seconds before an unanswered camped call is returned to the telephone which camped the call. Press CHANGE to select the setting: 30, **45**, 60, 90, 120, 150, or 180 seconds.

## Park timeout

Park timeout delay allows you to assign the number of seconds before a parked call on an external line returns to the originating telephone. Press CHANGE to select the setting: 30, **45**, 60, 90, 120, 150, 180, 300, or 600 seconds.

## Park mode

Press CHANGE to select the way that the system will choose a Call Park code: **Lowest** or Cycle.

When set to **Lowest**, the system will choose the lowest code that is available when the call is parked. When set to **Cycle**, the system will choose the codes in a sequence, from lowest to highest, until all the codes have been used.

## Trnsfr Callbck

Transfer Callback delay allows you to specify the number of rings before a Callback occurs on a transferred call. Press **CHANGE** to select the setting: 3, 4, 5, 6, or 12 rings.



**Tip** - You can estimate the delay in seconds if you multiply the number of rings by six.

## DRT to prime



Installer password required

Delayed Ring Transfer (DRT) automatically forwards unanswered external calls to a prime telephone, after a certain period of time. This helps ensure that no external call goes unanswered. Press **CHANGE** to select the setting: Y (Yes) or N (No).



**Tip** - An operational prime telephone must be assigned before this feature can operate. A prime telephone is assigned to one or more external lines under Lines in Trunk/Line data.

## DRT delay

Installer password required

DRT delay allows you to specify the number of rings before DRT transfers a call to a prime telephone. Press **CHANGE** to select the setting: 1, 2, 3, 4, 6, or 10 rings.



**Tip** - The DRT delay can be programmed only if DRT to prime is set to Yes.

You can estimate the delay in seconds if you multiply the number of rings by six.

## Held reminder

When active, Held Line Reminder reminds you that a call at your telephone is still on hold. You periodically hear two tones from your telephone until you return to the call on hold. Press CHANGE to select the setting: **N (No)** or **Y (Yes)**.

## Remind delay

Held Line Reminder delay allows you to choose the number of seconds before the Held Line Reminder feature begins at a telephone that has an external call on hold. Press CHANGE to select the setting: 30, **60**, 90, 120, 150, or 180 seconds.



**Tip** - *The Held Line Reminder delay can be programmed only if Held Line Reminder is activated.*

## Directd pickup

Directed pickup allows you to answer any calls by specifying the ringing telephone internal number. Press CHANGE to select the setting: **Y (Yes)** or **N (No)**.



**Tip** - *Directed pickup is not to be confused with the Call Pickup Group feature, which allows you to answer a call at any telephone within a specific group without specifying the internal number of the ringing telephone.*

*Like Call Pickup Group, Directed pickup is useful when not all the telephones have been assigned the same lines, but you still want to allow your co-workers to answer a call on any external line from their telephones.*

## Page Tone

You can choose whether a tone sounds before a page begins. Press CHANGE to select the setting: **Y (Yes)** or **N (No)**.

## Page Timeout

The paging feature is automatically disconnected after a set length of time. Press CHANGE to select the maximum number of seconds needed for a page: 15, 30, 60, 120, **180**, 300, 600, 2700.

## Daylight time

When this feature is turned on, the system will automatically switch between standard time and daylight saving time. Press CHANGE, to select the setting: **Y (Yes)** or **N (No)**.



**Tip** - *The time falls back one hour on the last Sunday of October at 2:00 a.m., and advances one hour on the first Sunday of April at 2:00 a.m. This function should only be programmed by your installer.*

*In areas where daylight saving time does not apply, (for example, Saskatchewan), make sure this setting is changed to N (No).*

## AutoTime&Date

The Automatic Time&Date feature enables the Norstar system to use incoming CLASS trunk call information to automatically update the time and date on the Norstar system. Press CHANGE to choose **Y** or **N**.

You can program the Automatic Time&Date feature to enable the Norstar system to automatically update the time and date after a power failure. Whenever the clock is out of sync by more than two minutes as a result of a power failure or a loss of power, the first incoming call updates the clock automatically after two rings.

CLASS trunks are required for this feature to work. Consult your customer service representative to determine if you have CLASS trunks.

This feature also allows the automatic changing between North American daylight savings and standard time. The Automatic Time and Date feature automatically overrides any manually programmed changes to the time and date in your system.

The year is not included with the time and date information and must be programmed manually if the current year differs from the network time.

Press CHANGE to choose **Y** or **N**.

## Call log space

Call log space programming customizes how log space is allocated to telephones in the system

### Reset all logs?

Reset all logs allows you to re-allocate the Call log space equally to all telephones in your system.

Press YES and use the dialpad to enter the space allocation for the Call log at each telephone. You must use a three-digit number (for example, 020 to give each set 20 spaces).

Press YES to accept the settings and end programming. The system automatically re-allocates Log space. Press NO to keep existing settings.



**Tip** - Use this heading only if you want to allocate an equal amount of log space to all the telephones in your system. If you want to assign specific amounts of log space to individual telephones, see the information under *Terminals&Sets* in the *Compact ICS 6.0 System Coordinator Guide*.

*Re-allocating Call log space may destroy Call log data at telephones that lose space.*

*There are 250 Call log spaces available in the system. No spaces are allocated by default. Changing the space allocation using Log Defaults defines the log space available to all telephones in the system. Any remaining unassigned log space is available in a log pool and can be re-allocated under Terminals&Sets in Telco features.*

## Host delay



Installer password required

Host delay allows you to assign the delay between the moment an outgoing line is selected to make an external call (for example, by lifting the handset off the telephone) and the moment that Norstar sends dialed digits or codes on the line. Press **CHANGE** to select the setting: 200, 400, 600, 800, **1000**, 1200, 1400, 1600, 1800, or 2000 milliseconds.



**Tip** - *Host delay is provided to ensure that a dial tone is present before the dialing sequence is sent. Minimizing this delay provides faster access to the requested features.*

*To calculate the precise delay between initiating the call and when the first digit is dialed, add 500 milliseconds to the setting. This will account for time used to set up the call.*

## Link time



Installer password required

Link time allows you to specify the duration of a signal required to access a feature through a remote system. Press **CHANGE** to select the setting: 100, 200, 300, 400, 500, **600**, 700, 800, 900, or 1000 milliseconds.

For example, to program external dialing through a Centrex system, which requires a Link time of 400 ms, select a Link time of 400.



**Tip** - *The correct Link time setting depends on the requirements of the host switching system you wish to access.*

*Link is another name for recall or flash.*

## Alarm set

Alarm set allows you to assign a telephone on which alarm messages appear when a problem has been detected in the system. Use **CHANGE** and the dialpad to enter the internal number of the Alarm telephone. Press **CLR** to set the Alarm telephone to **None**. The default setting is **21**.

## Set relocation

Telephone relocation allows you to move any telephone to a new location within the Norstar system without losing the directory number, autodial settings, user speed dial codes, and any system programming for that telephone. Press **CHANGE** to select the setting: **N (No)** and **Y (Yes)**.



**Tip** - *It is a good idea to activate Telephone relocation after the telephone installation and programming has been done. This will give you more flexibility when you are testing equipment.*

*If this feature is deactivated while a telephone is moved, that telephone's internal number and programming data remain with the physical port on the ICS, and the telephone does not receive the original programming when it is reconnected elsewhere.*

## Answer key

There are up to eight answer keys that can be assigned per set. The Answer key setting in Feature settings programming allows you to determine what types of calls will alert at the telephone.

Your choices are: Basic, Enhanced and Extended.

With the default Basic setting, answer keys do not ring for:

- Prime set call capture
- call forwarded calls
- other answer key calls
- priority calls
- voice calls



- ringing service
- callbacks

The Enhanced setting is the same as the Basic setting except that answer keys will ring for overflow call routed calls (special case of Prime set call capture). Answer keys will not ring for line transferred calls (although Basic will ring).

Extended will ring for all call types except priority calls and voice calls.

Press CHANGE to select the settings: **Basic**, Enhanced, and Extended.

### Phantom DNs

A line can be programmed to appear and ring on a set which physically does not exist. You can create an Answer key for the set on another telephone. This feature is useful if you discontinue a common number, such as a help-line number, and want to forward all those calls to the new number.

## Setting SWCA controls

You can assign up to 16 System Wide Call Appearance (SWCA) keys to each telephone in a group. This is performed using the Key programming heading under Terminals&Sets/User Preferences headings. SWCA controls are controlled by feature codes  $\square \square * \square \square \square \square$  to  $\square \square * \square \square \square \square$ . The user can also program this feature using these feature codes. Refer to the *Compact ICS System Coordinator Guide* for instructions about programming features onto memory keys.

On the system, under **Feature Settings**, **SWCA Cnt1** you define how incoming calls get associated to SWCA keys and how Hold will handle the calls.

The **Auto Associate** setting determines if answered calls will automatically be assigned to SWCA keys (**Auto Associate** = 'Y'). If you want the user to press the Hold button or a free SWCA key before the call transfers to a SWCA key, set **Auto Associate** to N. Calls remain assigned to SWCA keys for the duration of the call.

The **Invoke by Hold** setting determines if a SWCA call put on Hold can be picked up from other extensions in the group.

- If you want the call to be available to be picked up by other members of the groups when you put a call on Hold, set **Invoke by Hold:** to **Y**. A flashing indicator appears beside an available SWCA key when an incoming call is put on Hold.
- If you want calls to remain on Hold only at the telephone where the call is received, set **Invoke by Hold:** to **N**. Even if you set this field to **N**, users can still put selected calls on SWCA hold, by pressing a free SWCA key to put the call on Hold.

Refer to the System Administrator Guide sections on assigning key programming and for instructions about using the keys.

1. Under **Featr settings**, press . The display shows **Backgrnd music:**.
2. Press  until the display shows **SWCA Cntrl:**.
3. Press . The display shows **Auto Associate:** **N**.
4. Press **CHANGE** to choose the **Y** or **N** option.
5. Press . The display shows **Invoke by Hold:** **N**.
6. Press **CHANGE** to choose the **Y** or **N** option.
7. Press  to exit or  to continue programming.



**Tips** - *Since SWCA keys use the park feature, ensure that you have park turned on for your system by specifying a Park Prefix (Access codes), and a park timeout setting (System programming, Featr settings).*

## CLID Match

This setting determines the minimum number of digits that an external call must match to an existing system speed dial number in order for the system to offer a name display for the CLID prompt if the system speed dial number is set up to display the caller name. Refer to the *Module Plus System Administrator Guide* for information about setting up System Speed Dials.

1. Under **Featr settings**, press . The display shows **Backgrnd music:**.
2. Press . The display shows **Backgrnd music:** **N**.

3. Press  until the display shows **CLID match: 8**.
4. Press **CHANGE** to select the a number from 3 to 8, or select None, if you do not require any number matching.
5. Press  to exit or  to continue programming.

## Direct-Dial

Direct-dial allows you to dial a designated telephone with a single digit. The direct-dial telephone can be inside the Norstar system or it can be outside the system in the public network. The direct-dial telephone is usually assigned to a receptionist for an entire office or for a particular department.

The direct dial code is entered under Access Codes.

### D-Dial1

For the direct-dial telephone, indicate whether it is an internal or external number.

Use  and **CHANGE** to select the setting: **Intrnl**, **Extrnl**, or **None**.

### Number

Enter the internal or external number that the system will automatically dial when someone enters the direct-dial digit.

Use , **CHANGE**, and the dialpad to enter the telephone number. The default number for the direct-dial telephone is **21**.

### Line selection

If you assign an external number as a direct-dial telephone, you must indicate which line to use for the call.

Use  , **CHANGE**, and the dialpad to select the line for the external number.



**Tip** - *There is just one direct-dial digit for the entire system.*

*The Norstar system cannot verify that the number you assign as an external direct-dial telephone is valid. Check the number before assigning it as a direct-dial telephone, and call the direct-dial telephone after you've assigned it in order to test it.*

*You cannot forward calls to any direct-dial telephone that is outside your Norstar system. See Call Forward in the Compact ICS 6.0 System Coordinator Guide.*

## CAP assignment



Installer password required

This setting designates a telephone as a central answering position (CAP). The CAP must be an M7324 telephone with a CAP module attached. The default CAP assignment is **None**.

The CAP may be used to:

- monitor the busy/not busy and Do Not Disturb status of Norstar telephones
- answer external calls and extend calls to other Norstar telephones
- send up to 30 messages to other Norstar telephones
- provide up to 48 extra memory buttons for the telephone.

Use  , **CHANGE**, and the dialpad to enter the internal number of the M7324 telephones to be designated as a CAP. The set must be installed before you make it the CAP.



**Tip** - *If a CAP module is attached to an M7324 telephone that has not been programmed as a CAP, you will not be able to move line buttons onto the CAP module. The CAP will still be associated with the telephone and have some default programming.*



**Tip** - If a CAP module is relocated with the telephone, the settings are retained. A station auxiliary power supply (SAPS) is required for M7324 telephones that have one or more CAP modules attached.

*You can reset a CAP module by simultaneously pressing the two buttons on the bottom left-hand side and the two buttons on the bottom right-hand side. This must be done immediately after the module has been plugged in. Performing Startup will not erase CAP programming.*

## Access codes

Access codes are used by the system to direct calls to the correct lines and destinations. If the codes conflict, some of the features on the system will not work. The table of default settings can help you plan your access codes so there are no conflicts. It assumes you are using a fully expanded Compact ICS. See the wiring information in the Installation chapter for DN numbering for smaller configurations.

### Digits assigned by default to programming settings

Digit	Use	Heading
0	direct-dial digit	Access codes
1	Park prefix	Access codes
2, 3, 4	the first digit of B1 DNs	Startup
4 and 5	the first digit of B2 DNs	Startup
7	the first digit of ISDN DNs	Startup
8	the first digit of DNs used with the CTA 500dm	Startup
9	external line access code	Access codes
— —	line pool access code (Not assigned by default, but takes precedence over the External Line access code if there is a conflict.)	Access codes
— —	destination code	Services

## Line pool codes



Installer password required

This setting allows you to assign a line pool access code for each of the three line pools (A to C). These codes are used to specify the line pool you wish to use for making an outgoing external call. Use  , **CHANGE**, the dialpad, and **OK** to program the access code. The default access code is **None**.



**Tip** - *The code can be one to four digits in length. Line pool access codes starting with the same digit must be the same length.*

*A line pool access code can be the same as an external line access code. In this case, the line pool access code takes priority over the external line access code, and a line from the line pool is selected.*

*A line pool access code cannot conflict with:*

- *the Park prefix, the direct-dial digit*
- *the first digit of any Received number*
- *the first digit of any DN (including the Auto DN or the DISA DN)*

## Park prefix



Installer password required

The Park prefix is the first digit of the call park retrieval code that must be entered to retrieve a parked call. If the Park prefix is set to None, calls cannot be parked. Press **CHANGE** to select the setting: 1 to 9, None, or 0.



**Tip** - *The Park prefix cannot be the same as*

- *the direct-dial digit*
- *the external line access code*
- *the first digit of a DN*
- *the first digit of a line pool access code*
- *the first digit of a destination code*

*Other programmable settings may affect which numbers appear on the display during programming. Although the numbers 0 to 9 are valid Park prefix settings, some may have been already assigned elsewhere.*

*If DN length is changed, and the changed DNs conflict with the Park prefix, the setting changes to None.*

## External code



Installer password required

External code allows you to assign the external line access code. This code is used to allow M7100 and T7100 telephones and Analog Terminal Adapters (ATA) to access external lines.

Use **CHANGE** to select the setting: 1 to 9, None, or 0.



**Tip** - *The external line access code cannot conflict with*

- *the Park prefix*
- *the direct-dial digit*
- *the first digit of a line pool access code*
- *the first digit of a DN*
- *the first digit of a destination code.*

*If DN length is changed, and the changed DNs conflict with the external line access code, the setting changes to None.*

## Direct-dial #



Installer password required

Direct-dial digit allows you to dial a single, system-wide digit that can be used to call a specific telephone, called a direct-dial telephone. Press CHANGE to select the setting: 1 to 9, None, or **0**.



**Tip** - *Another direct-dial telephone, an extra-dial telephone, can be assigned for each schedule in Services programming.*



**Tip** - *The direct-dial digit cannot be the same as the first digit of:*

- *a DN*
- *a line pool access code*
- *the external line access code*
- *the Call Park prefix*
- *a destination code*

*If DN length is changed, and the changed DNs conflict with the direct-dial digit, the setting changes to None.*



## Auto DN



Installer password required

For calls answered without DISA, no password is required to access the Norstar system. The Class of Service (COS) that applies to the call is determined by the COS for the trunk on which the user is calling. Use **CHANGE** and the dialpad to enter the digits to be received from the auto-answer trunk.

Press **CLR** to set the Auto DN back to **None**.



**Tip** - *The length of the Auto DN is the same as the Rec'd # length specified in System prgming. The Auto DN is cleared if the Received number length is changed.*

*The Auto DN cannot be the same as a line pool access code or a destination code.*

*The Auto DN can give remote access to callers using the Auto Attendant. To make features available to callers who enter the Auto DN, lines answered by Auto Attendant must be configured with a remote access package.*

## DISA DN



Installer password required

For calls answered with DISA, the system presents a stuttered dial tone to prompt a caller to enter a valid password. The Class of Service (COS) that applies to the call is determined by this COS password.

Once a remote user is on the Norstar system, the DISA DN can be used to change the existing Class of Service. This gives you greater flexibility when you create access privileges. For example, you may want to have a shared DN for remote access and separate COS passwords with different dialing out privileges for individuals.

Use **CHANGE** and the dialpad to enter the digits to be received from the auto-answer trunk. Press **CLR** to set the DISA DN to **None**.



**Tip** - *The length of the DISA DN is the same as the Rec'd # length specified in System prgming. The DISA DN is cleared if the Received number length is changed.*

*The DISA DN cannot be the same as a line pool access code or a destination code.*

## Auto Attendant

Two of the settings for Auto Attendant, Auto Attend and CCR lines, are programmed using an Installer or System Coordinator Plus password.

### Auto Attend

This setting makes the Auto Attendant features (System Answer and Custom Call Routing) available to the system. System Answer automatically responds to unanswered calls at the attendant set and puts them on hold until they can be retrieved. Custom Call Routing allows callers to direct their call using an audio menu.

Use **CHANGE** to toggle the setting: ON or **OFF**.



**Tip** - *If a peripheral auto attendant or Custom Call Routing device is used with the system, turn the setting to OFF.*

### Fax switch

The Fax switch feature monitors incoming Auto Attendant lines and automatically transfers calls to a fax machine when it hears a fax tone. The Fax switch contains all of the required Fax tone detection and transfer abilities within the Norstar system.

This feature allows one Fax DN.

1. At System prgming, press  until Hunt groups displays.
2. Press  until Fax DN:None displays.
3. Press **CHANGE** and enter the Fax DN.
4. Make the required changes for the Fax switch in the Auto-attendant documentation. Auto-attendant programming is covered in the documentation that came with the CallPilot system attached to your CICS.

The Fax switch identifies one DN and does not support the unique definition of a number of Fax devices. To support a collection of Fax devices:

- use the Forward on Busy setting on a set
- use the Hunt group functionality to collect all fax devices under one DN

## CCR

Custom Call Routing (CCR) allows calls on certain lines to be directed to a telephone or group of telephones according to a numbered menu heard by the caller.

### CCR lines

Press  and **CHANGE** to choose which lines will be answered by the CCR feature. The options are **YES** and **NO**. There is no limit to the number of lines that can be monitored by CCR.

Additional programming can be done using the System Coordinator password.

Setting	Description	Options
Attd Set	Select the set which will have its lines answered by System Answer.	Enter DN 21
Language	Select the language or languages used for the pre-recorded announcements.	
•First	Select the first language.	English, French or Spanish

Setting	Description	Options
•Second	Select the second language, if applicable.	(one of the remaining options) None
System Answer	This feature answers external calls and places them on hold at the attendant set until the attendant/receptionist can answer them.	
•After	Select the number of rings that the caller will hear before the system answers.	between 1 and 12 rings (3)
CCR	Custom Call Routing (CCR) allows calls on certain lines to be directed to groups of telephones according to the instructions from the caller.	
•After	Select the number of rings that the caller will hear before the system answers.	between 2 and 12 rings (3)
•CCR groups	Create groups of DNs to be used with the CCR.	
••CCR group <i>n</i>	Enter the number of the group, then enter the DN of the set that you want to assign to the group.	CCR groups 1-9 (no DNs assigned by default)

**Note:** The Compact ICS 6.0 standard software, I-RAD enabled, AutoAttendant with programmable prompts configuration gives you the capability to replace default Auto Attendant prompts with customized prompts. See the *Compact ICS 6.0 System Coordinator Guide* for complete information on programming Auto Attendant features.

## Remote access

Remote access packages allow you to control the remote use of Norstar line pools and the paging feature. Packages are also used to control remote administration and monitoring of the system.

You create a remote access package by defining which of your system line pools it will be able to access and whether it can use Page, line pools and remote administration. You then assign the package to individual lines (using Rem line access), and to a particular Class of Service password (Remote pkg in COS passwords).

## Remote access pkgs

Use  and the dialpad to select the remote access package you want to program.

## LinePool access

Press CHANGE to select the line pool access setting for each pool: N (No) or Y (Yes).

## Remote page

Press CHANGE to select the Remote page setting: N (No) or Y (Yes).

## Remote admin

Press CHANGE to select the Remote administration setting: N (No) or Y (Yes).

## Remote monitor

Press CHANGE to select the Remote monitor setting: N (No) or Y (Yes).

## Rem line access

Enter the number of the line which will be accessible by remote users.

## L001

Press CHANGE and enter the number of the remote access package that will apply to remote use of the line.

## Remote access packages defaults

Parameter	Square	PBX	Hybrid
<b>Package 00</b>	Prohibits remote access to line pools, Page, remote monitoring and administration. Cannot be changed.		
<b>Package 01</b>			
Line pool access	Y for Pool A N for Pools B and C		
Remote Page, administration & monitoring	No		
<b>Packages 02 - 15</b>			
Line pool access	N for Pools A to C		
Remote Page, administration & monitoring	No		



**Tip** - You can use COPY and the dialpad to copy settings from one remote package to another.

The line pool access display shows an alphabetic line pool identifier, followed by a numeric line pool access code in brackets (for example, P001A (9)N). If no access code has been identified, there is nothing between the brackets (for example P001A ( )N). The line pool access code are programmed under Access codes.

Remote package 00 is the default setting for the Remote package setting. It permits no access to line pools or to remote paging. Unlike packages 01 to 15, package 00 cannot be changed. You can define up to 15 remote access packages (01 to 15).



**Tip** - *For remote users who call into the Norstar system to use Norstar lines for calling out, the remote restrictions and line restrictions still apply.*

To use features on a Norstar system remotely, press \* followed by the feature code. Even if you are calling from another Norstar system, press \* instead of ⓪.

## I-RAD

The internal remote access device (I-RAD) can be programmed to answer an incoming call automatically. This allows you to set up remote administration without the help of someone on site. The I-RAD is an optional feature for some versions of the Compact ICS Feature Cartridge. If the I-RAD is not available, it can be enabled using software keys supplied by Nortel. See *Software Keys* on page 242 for more information.

## Answer line

Press CHANGE until you have selected the line you wish to use, or **None**. Choose an incoming line that is configured as manual answer, or a target line. You cannot choose a line which is automatically answered by CCR.



**Tip** - *If the answer line you choose is part of a Multi-Line Hunt feature, the call may be directed to another line and the I-RAD will miss the call. For reliable access to the I-RAD, use a line that is not part of a hunt group.*

## After

Press CHANGE to select the number of rings (between one and 12) before the I-RAD will answer an incoming call on the line. The default is **5 rings**.

## Rec'd # length



Installer password required

The received number is used to identify the mapping of incoming calls to target lines, Auto DN's, and DISA DN's. The length of the number may be the same as the system DN length, or may be set to some other value because of network or central office constraints. Changing the Received number length clears all received digits programming for target lines.

To change the number of digits received on auto-answer trunks:

1. Press CHANGE to select the setting: 2, 3, 4, 5, 6, or 7.
2. Press  to save the new received number length. The display shows Clear rec'd #s? Press YES to go ahead with the change. All received digits programming for target lines is cleared.



**Tip** - *The target line number (for example, line 052) and the Received number for the target line (for example, Rec'd #: 123 for line 052) are two different numbers.*



## DN length



Installer password required

This feature allows you to change the number of digits for all DNs. The maximum length is seven. The default and minimum length is 2.

1. Press **CHANGE** to select the setting: 2, 3, 4, 5, 6, or 7. Press  to save the new DN length. The display shows **Drop data calls?** Press **YES** to save the new DN length. **NO** restores the original value.



### ***Do not change DN length immediately after a system startup.***

You must wait for at least two minutes after a system startup before you change the DN length.

If you have Hunt Groups or Hospitality Services, the DN length must be a minimum of three digits.



### ***Data devices will drop calls.***

Norstar data devices (not ISDN terminal equipment) drop calls when the DN length is changed. (These data devices use the B2 channel. Business Series Terminals and Norstar telephones use the B1 channel. Calls are not dropped for these telephones.) Norstar data devices which use the B2 channel include the PCI-B used for computer applications and Norstar voice mail.

The DN length change is completed within two minutes, depending on the size of the installed Norstar system. System response may briefly slow down during this time. You cannot re-enter programming during this time. If you enter the programming access code, the message **In use: SYSTEM** appears on the display.



**Tip** - A DN length change, if required, should be the first programming change on a newly installed Norstar system.

Each increase in length places the digit 2 in front of any existing DN. For example, if DN 34 was increased to a length of 4, the new DN would be 2234.

If the DN length is changed so that a conflict is created with the Park prefix, external line access code, direct-dial digit, or any line pool access code, the setting for the prefix or code is changed to None, and the corresponding feature is disabled.



#### **DN length for Compact ICS 4.0**

It is recommended that new Compact ICS 6.0 systems use three-digit (or more) DNs.

## **Changing DN length from two digits**

The following scenarios indicate some of the consequences of changing or retaining the two-digit DN length.

1. A coldstart or upgrade to version 6.0 but retaining two-digit DNs
  - No Hunt groups or Hospitality Services
  - No Hunt group DNs
2. Change DN length from two digits to more than two using the Change DN length feature in System Prgming and choosing Yes to the 'Drop all calls' prompt
 

**or**

Change DN length from two digits to more than two using the Change DN length button in Norstar Remote Utilities (NRU) and choosing Yes to the 'Restrict access to the rest of the programming tree and reset memory if the length is changed to 2' message:

- DN length changed
  - Hunt groups and Hospitality services features are available
  - Hunt group DNs exist
3. Change DN length from three-digit length to more than three-digit length using the Change DN length feature in System Prgming and choosing Yes to the 'Drop all calls' prompt
- or**
- Change DN length from three-digit length to more than three-digit length using the Change DN length button in NRU and choosing Yes to the 'Restrict access to the rest of the programming tree and reset memory if the length is changed to 2' message:
- DN length changed
4. Change DN length from non-two-digit length to two-digit length using the Change DN length feature in System Prgming and choosing Yes to the 'Reset memory' prompt
- or**
- Change DN length from non-two-digit length to two-digit length using the Change DN length button in NRU and choosing Yes to the 'Restrict access to the rest of the programming tree and reset memory if the length is changed to 2' message:
- Coldstart will occur
  - Alarm 79 will be logged followed by the DN of the set from where the session was running

## Network Name Display



Installer password required

Norstar will display the name of the calling party when it is provided by Public ISDN BRI interfaces. The displayed name may include information such as the Receiving Calling Name and Receiving Redirected Name.

## Receiving Calling Party Name

Network name display allows the name of an incoming BRI call to be displayed on the Norstar set receiving the call.

Calling Party Name with status of PRIVATE may be displayed on the Called Party set as Private name. If the incoming Calling Name is defined by the CO as a private name, then Private name appears on the answering set. If the Calling Party Name is unavailable it may be displayed on the Called Party set as Unknown name.

## Receiving Redirected Name

Network name display allows the receiving of the Originally Called Name (Redirecting Name) on incoming calls. The Originally Called Name will be stored, but not displayed.

## Network Name Display interactions

Calling Name information is passed between trunks with Selective Line Redirection (SLR). Only Calling Name information is passed between trunks in cases where Direct System Inward Access (DISA) has resulted in tandeming of trunks.

## Intrl modem



Installer password required

The internal modem used for remote programming or monitoring can operate at two different speeds. The fast speed setting uses the V.32 bis modem standard, which supports baud rates of 4.8 kbps to 14.4 kbps. In some cases, network limitations may prevent the modem from connecting at the fast speed. If you consistently have problems making calls to or from particular destinations, select the slow setting for the modem. The slow speed setting is designed for the V.22 bis standard (2400 baud) and is much less likely to suffer from problems originating on the network.

Press CHANGE to select the setting: **Fast** or Slow.



***Changing the speed of the modem will force the system to restart.***

## Fixed modem settings

No parity

8 data bits

1 stop bit



**Tip** - *Disable the following high-level protocols at your modem when attempting a connection with the Compact ICS modem: V. 42, V. 42bis, MNP5, MNP10, enhanced throughput cellular (ETC). Possible command strings that would be used to disable these protocols are at&m0, atln0, or at&q0. Check the documentation that comes with your modem for the proper command(s).*

*If you are sending out automatic alarm reports using the I-RAD, you should set the modem speed to support the baud rate of the device that receives the alarm report.*

*If your system has access to a Basic Rate Interface (BRI) network, use a digital trunk supplied by a BRI Card for modem calls to get the best transmission quality.*

## Alarm reporting



Installer password required

The Alarm Reporting subheading will not appear unless your Feature Cartridge comes with remote administration enabled, or you have enabled the feature using software keys. See the I-RAD chapter and *Software Keys on page 242* for more information.

The Norstar system can use the internal remote access device (I-RAD) to automatically send an alarm code to a remote location when it detects a significant event. Detailed information about the alarm codes is included in the Maintenance chapter.

When an alarm code is generated, the system can call up to two pre-programmed numbers and transmit the code as a string of ASCII text. To activate the feature, you must set Auto-report to ON, and program at least one telephone number and outgoing line.

If the call to the remote telephone number is not successful, the system will retry the call after a pre-programmed length of time. If the alarm code has not been transmitted after a pre-programmed number of retries, it will be cleared from the system. The alarm code which appears at the Alarm telephone and is recorded in the System test log is not affected by the Alarm reporting settings.

If there are multiple alarms and a backlog of codes is created, the system stores a maximum of five codes in a queue. If a sixth alarm is generated, the first code in the queue is dropped.

The baud rate you select for the device which will receive the alarm report should support the baud rate of the Compact ICS internal modem. See page 228 for more information.

## Auto-report

Press CHANGE to select the setting: **OFF** or **ON**.

## Phone #1

Press CHANGE and enter the telephone number the system will dial to transmit an alarm code. Press OK when you have finished entering the number. It can be up to 24 digits long.

Press CLR to choose **None**.

## Phone #2

The system calls the second number after the alarm is transmitted to the first number, or after trying to transmit the first number for the programmed number of retries.

Press CHANGE and enter an additional telephone number the system will dial to transmit an alarm code. Press OK when you have finished entering the number. It can be up to 24 digits long.

Press CLR to choose **None**.



**Tip** - *You can use host signaling codes in your alarm reporting telephone numbers.*

## Use line

Press CHANGE and enter the number of the line the I-RAD will use to send an alarm code. The line cannot be a target line, a line that is private to a DN, and you cannot use a line pool code.

Press CLR to choose **None**.

## Retry time

Press CHANGE and enter the length of time in minutes the I-RAD will wait before trying the pre-programmed telephone number again. Enter a number between 1 and 50.

Press CLR to reset Retry time to the default (**15** minutes).

## Num. retries

Press CHANGE to select the number of times the system will retry the transmission of the alarm code: 0, 1, 2, 3, 4, **5**, 6, 7, 8, 9.

Press CLR to reset the number of retries to the default (**5** retries).



**Tip** - *Unlike an external RAD, the I-RAD alarm reporting feature does not require you to set the baud rate or parity. Alarm reporting can use any lines which are not private to a DN or target lines.*

*Because alarm reporting is an internal system feature, alarms indicating major events such as a system failure may not be transmitted.*



**Tip** - *It is recommended that you program the system to make at least one retry of the alarm reporting telephone number.*

## Release Reasons

Installer password required

This feature is useful for diagnostic purposes. It shows the reason why an ISDN call has been released. The Release Reason can be displayed as Simple or Detailed text. When the default **None** is selected, no release reasons appears on the set.

Release Reasons can be programmed under System prgming. With the display showing **System prgming**.

1. Press  until the display shows **Release reasons**.
2. Press . The display shows **Text: None**.
3. Select the text to be displayed as **Simple** or **Detailed**.

If you selected Simple text, press  for Cause code. The **Cause code** is for diagnostics. Make sure it is set to **H**.

## Hospitality Services

The Hospitality heading accesses the settings for the room and alarm information.

With the display showing **System prgming** press  until the display shows **Hospitality**.

## Room/desk information

Use this setting to assign set DNs to a specific room.

1. At the Hospitality heading, press . **Room/desk info** displays.
2. Press . **Show set: displays**.
3. Enter a room set number or press **LIST** and press  until you find the DN of the set you want to assign to a room.
4. Press . **Room #:None** displays.
5. Press **CHANGE** and enter the room number, then press **OK** to accept the change.
6. Repeat step 6 for all the sets you want to assign.
7. Press . **Adm Pwd read:Y** displays



- Press **CHANGE** and choose **V** or **N**, depending on your security requirements.

## Call restrns

You can set up call restrictions based on room occupancy states. This setting affects the Room occupancy feature.

- At the Hospitality heading, press  twice. **Call restrns** displays.
- Press . **Vacant:00** displays.
- Press **CHANGE** and enter the filter that defines the restrictions for your hospitality system.
- Repeat steps 2 and 3 for the other room occupancy states.

The table below shows an example of a call restrictions setup.

Room Occupancy	Filter	Description
Vacant	11	no calls allowed except 911
Basic	11	no calls allowed except 911 and internal extensions
Mid	12	no calls allowed except 911, 1800, 188 and internal extensions
Full	13	no call restrictions

## Service times

You can set the time when occupied rooms change from Service done to Service required. This setting affects the Room condition feature.

- At the Hospitality heading, press  until **Service time** displays.
- Press . **Hour: 00** displays.
- Press **CHANGE** and enter the hour (00 to 23).
- If the number is less than 13, the display shows **AM**. Press **CHANGE** to select **PM**, if required. Press **OK** to accept.

5. Press . **Minutes: 00** displays.
6. Press **CHANGE** and enter the minutes (00 to 59).

## Alarms

Use this feature to create the alarm settings that will govern the alarm features for both the administrative and room sets.

1. At the Hospitality heading, press  until **Alarm** displays.
2. Press . **Attn attempts:3** displays.
3. Press **CHANGE** until you find the number you want (1-5).
4. Press . **Retry intrvl:4** displays.
5. Press **CHANGE** until you find the number you want (2, 4, 6, or 8).
6. Press . **Attn duration: 15** displays.
7. Press **CHANGE** until you find the number of seconds you want (10, 15, 20, 30, 40, 50).
8. Press . **Time format:12 hr** displays.
9. Press **CHANGE** to choose either **12hr** or **24hr**.
10. Press . **Expired alarms** displays.
11. Press . **Notify set:None** displays.
12. Press **CHANGE** to enter a set DN to be notified.
13. Press . **Use tone:N** displays.
14. Press **CHANGE** to choose either **Y** (yes) or **N** (no).

---

# ETSI: Network features (profile 2)

---

If you are using Profile 2 for your system, and your service provider supports the features on your ETSI ISDN lines, you can configure your system to allow network diversion and/or Malicious Caller ID (MCID) recording.

To program these features:

1. With the display showing **System Programming** press  until the display shows **NetworkServices**.
2. Press . ETSI displays.
3. Press  **Network Redirection** displays.
4. Press **CHANGE** to choose either **Y** (yes) or **N** (no).
5. Press . MCID displays.
6. Press **CHANGE** to choose either **Y** (yes) or **N** (no).

## Malicious call identification (MCID)

The MCID feature allows the user to press     to have call information recorded on the central office system for an incoming call on a specific line (ETSI PRI lines, only).

The user must invoke the feature code either during the active call or within 30 seconds (time varies on different networks) after the caller hangs up. The feature will not work once the called party hangs up.

**Note:** This feature must be allowed in network programming for your PRI lines from your service provider.

The following information registers on the network:

- called party number
- calling party number
- local time and date of the invocation in the network serving the called user
- service provider option: calling party subaddress, if provided by calling user)

## Network Call Diversion

Norstar Network Call Diversion (NCD) is a network function that allows forwarding and redirection of calls outside the Norstar network when using an ETSI ISDN line. Functionality is similar to that of External Call Forward (ECF).

NCD redirects calls using the same line on which they arrive. Call forward is efficient since there is no need for additional outside lines.

Forwarding calls externally from an extension requires the user to enter either a Destination Code or Line Pool Access Code, and the number to which calls will be forwarded.

Examples of NCD include:

- redirecting all calls from an extension to a mobile phone
- forwarding calls to an external destination (rather than to voicemail), when an extension is busy or the user is unavailable.

### Feature description

NCD is available only over ETSI ISDN lines. It can be invoked when calls are presented to Norstar/BST extensions over ISDN lines. The user must program the selected extension.

NCD is integrated with the following existing Norstar Call Forward features:

- Call Forward Unconditional (CFU)—implemented on Norstar Call Forward All Calls (CFAC)   4, and Selective Line Redirection (SLR)   4, also referred to as Line Redirection. This is programmable by the user.
- Call Forward on Busy (CFB)—implemented on Norstar Call Forward Busy.
- Call Forward on No Response (CFNR)—implemented on Norstar Call Forward No Answer.

For example:

- When a call comes in on ETSI ISDN and is returned to a destination being serviced by ETSI ISDN, BTNR 191, Analogue or DASS2 lines, then ETSI Call Forward (CFU, CFB or CFNR) is used.
- When a call comes in on ETSI ISDN and is returned to a private network destination over DPNSS, then External Call Forward (ECF) is used.
- When a call comes in on DPNSS 1 and is returned on any line type except DPNSS 1, ECF is used. If that call is returned over DPNSS, however, then DPNSS 1 Diversion (DIV) is used. Refer to *Network Call Diversion on page 236*
- When a call comes in on any other line type, such as AC15A, then again ECF is used. Note that under certain line conditions, ECF will not work; refer to Line Redirection restrictions.

**Note:** In all cases, if NCD fails due to network errors or rejections, Norstar invokes ECF. If an outgoing line is unavailable, Norstar routes the call to the line's prime extension.

## Programming and restrictions

NCD features are accessed through existing Norstar features. Extensions requiring redirection must be programmed individually to either CFAC or SLR. CFB or CFNA must be set during programming. `Allow redirect` must be set to Yes for each extension, in `Terminals&Extns` Capabilities.

**Note:** Any other programming applied to specific lines and extensions take precedence, for example `Restrictions(extns)` under `Terminals&Extns`.

NCD is used as long as the affected lines are ETSI ISDN, and the affected DIA lines are accessible via ISDN lines. Incoming calls are diverted back to the ISDN. If NCD fails due to network errors, ECF is invoked. If ECF cannot be executed, the incoming call is routed to the line's prime extension.



### ATTENTION!

**If a line is configured to appear on several extensions with redirection programmed, predicting which extension will divert the call is not possible. This should be considered during system configuration.**

An extension with CFB, CFNA and CFAC programmed will give priority to CFAC for diversion.

## Selective Line Redirection

Selective Line Redirection (SLR), also referred to as Line Redirection, is enhanced for use with digital lines and operates in conjunction with NCD.

Diversion by SLR takes precedence over diversion by CFAC. An SLR line cannot be diverted by CFAC. If the call arrives on an extension with SLR programmed, a ring splash will sound (if programmed).

For information on SLR restrictions refer to *Selective Line Redirection on page 238*. For information on redirecting lines see Line Redirection in the *Modular Plus System Administration Guide*.

## Programming Extensions





The User Interface for programming NCD is the same as for ECF.

Different types of Call Forward are available depending on the extension being programmed. Programming an extension to forward calls externally requires the user to enter a destination code or line pool number, in addition to the external phone number. Therefore, care should be taken to identify your network line types and record the available codes and line pools.

---

## Enhanced Caller ID

When a Norstar/BST extension which has Call Line Identifier (CLID) active receives a redirected call due to NCD, the user will see the DN for the Calling Number. This is followed by a “>” and the redirecting number. This is displayed for as long as the call is active (alerting or answered) at that telephone.

If the alerting extension is not the CLID extension for that line, the line appearance can be pressed to briefly display the information. Pressing     or **INFO** while the call is active invokes Call Info. Call Info on DPNSS displays the redirecting number and the reason for the redirection.

**Note:** When Norstar requests that an incoming call be redirected by the distance network, Norstar does not inform the network of the redirecting DN. In this case, the diverted-to party will not see the diverting party DN.

# Telco features

## VMsg centr tel#s

If you subscribe to a voice message service outside your office, you can access it through your Norstar system. This setting specifies the external telephone numbers that are dialed by the Message feature to retrieve voice messages. Use  Show ,  Next , **CHANGE**, and the dialpad to enter the external number.

The default for each voice message center is **No number**.



**Tip** - A telephone does not show that external voice messages are waiting unless Extl VMsg set is set to Yes. The setting is in CLASS assignment under Terminals&Sets.

*You can program up to five voice message center numbers, but most systems require only one.*

## Outgoing Name and Number Blocking

When activated,  8  1  9 blocks the outgoing name and number. When this feature is used, the call is flagged to the CO so that the name and number will not be presented to the person being called.

On feature supported trunks, a call blocking digit sequence is sent to the CO before sending the dialout digits. You can change this digit in System Prgrming and set it to the digit sequence recognized by the local CO for name and number blocking.

To program the Name and Number blocking digit, start with the display showing **Telco features**.

1. Press  Show  . The display shows **VMsg ctr tel#s**.
2. Press  Next  until the display shows **ONH Blocking:**.
3. Press  Show  . The display shows **Analog VSC** or **BRI VSC** .



**For Analog VSC**

4. Press  . The display shows **Tone:None** .
5. Press **CHANGE** to enter a new tone dialing Name and Number blocking digit sequence.
6. Press  . The display shows **Pulse:None**.
7. Press **CHANGE** to enter a new pulse dialing Name and Number blocking digit sequence.

**For BRI VSC**

8. Press  . The display shows **Code** .
9. Press **CHANGE** to enter a new ONN code.

---

# Software Keys

---

In order to upgrade a restricted feature cartridge or enable the remote administration feature (I-RAD) you must first purchase the required Software keys. To obtain the required Software key, call the Integrated Voice Response (IVR) access line at: **1-800-4NORTEL (667835)**, then use Express Routing Code **1599**.

Entering the keys is done using the following programming settings under Software Keys.

## SysID

Press  at **Software Keys**. The display shows **SysID:** followed by the eight-digit System ID Number.

## Password Keys

Press  and enter the eight-digit password number for **Key1**. Use **BACK** to make corrections.

Enter the next two keys in the same way.

If you are upgrading a restricted feature cartridge, you will have to tell the system to go ahead with a restart. Entering the software keys will have no effect unless you perform the system restart.



**Tip** - *You will not know if the software keys are being entered successfully until all of the eight-digit numbers have been entered. You will see the numbers on the screen as you enter them and you will be able to make corrections.*

*You must assign a remote access package which allows remote administration to an incoming line before you can use the I-RAD.*

Record the codes in the *Compact ICS 6.0 Programming Record*. You will need the codes to restore the upgrade after a cold start.

# Hardware

Hardware is where you view and change the settings for the Trunk Cartridges and BRI Cards installed in the ICS.

The ISDN section provides an overview of configuration and programming for ISDN resources, including step-by-step instructions for programming. This section provides more detailed information about individual headings and settings.

## Hardware settings that appear for each cartridge or card type

Setting	Loop start	BRI-ST		BRI-U2 or BRI-U4	
		S loop	T or S loop	LT-loop	NT-loop
Card type	✓	–	–	–	–
Lines	✓	–	–	–	–
Discon timer	✓	–	–	–	–
Loops	–	✓	✓	✓	✓
Loop	–	✓	✓	✓	✓
Type	–	✓	✓	✓	✓
SPID1	–	–	✓	✓	–
# of B-channels	–	–	✓	✓	–
Network DNs	–	–	✓	✓	–
Call type	–	–	✓	✓	–
D-packet service	–	–	✓	✓	–
Lp<xxx>	–	–	✓	✓	–
TEIs	–	–	✓	✓	–
Sampling	–	✓	–	–	–
DNs on Loop <xxx>	–	✓	–	–	✓
Assign DNs	–	✓	–	–	✓
Loop DN	–	✓	–	–	✓

## Cd1-KSU



Installer password required

Press  to display the Trunk Cartridge or BRI Card in the ICS.

Press **CHANGE** to select a card type: **Loop**, BRI-U2, BRI-U4, or BRI-ST.

If your system is using a restricted feature cartridge that has not been upgraded, you cannot select the BRI-ST and BRI-U4 card types, or configure the second cartridge or card in the ICS (Cd2-KSU).

KSU is commonly referred to as the Integrated Communication System (ICS).



**Tip** - *The Trunk Cartridge slots in the ICS are numbered from left to right.*

### Card type

The display shows the current card type.

### Lines

The display shows the range for the lines on a Trunk Cartridge.

If your system is using a restricted feature cartridge that has not been upgraded, you will see only settings for Cd1-KSU.

If your system is using BRI-U2 Cards, only the first two loops appear for the card.

	Line numbers for Loop start
<b>Cd1-KSU</b>	001-004
<b>Cd2-KSU</b>	031-034

## Discon timer



Installer password required

Disconnect timer allows you to specify the duration of an open switch interval (OSI) before a call on a supervised external line is considered disconnected.

Press **CHANGE** to select the setting: 60, 100, 260, **460**, or 600 milliseconds.



**Tip** - *Disconnect Supervision is assigned to each line with the Trunk mode setting in Trunk/Line data under Lines (see page 155).*

*This setting must match the setting for the line at the central office.*

*This setting only appears for Loop Trunk cartridges.*

## Loops



Installer password required

The display shows the loops found on the BRI Card.

If your system is using a restricted feature cartridge that has not been upgraded, you will see only settings for Cd1-KSU

Loop numbers for BRI cards	
Cd1-KSU	201-204
Cd2-KSU	231-234

## Loop



Installer password required

Press  to display the settings for individual loops on a BRI Card.

## Type



Installer password required

Press **CHANGE** to select the loop type. If the card type is BRI-ST, the loop type can be S, or T. If the card type is BRI-U2 or BRI-U4, the loop type can be LT or NT.

The BRI Card must be disabled under Module Status in Maintenance before this setting can be changed. You can change the setting if the card has not yet been installed in the ICS slot.

## Lines



Installer password required

There are two lines for each T, S, or NT-loop.

Loop	Default lines
201	001-002
202	003-004
203	005-006
204	007-008
231	031-032
232	033-034
233	035-036
234	037-038

## No SPIDs assigned



Installer password required

T, S, and NT-loops can be assigned a service profile identifier (SPID) as supplied by your service provider. No SPIDs are assigned by default.

Note: Profile 2 sites do not use SPIDs.

When the loop type is T or NT, calls on the loop are handled for a network connection only. If any other ISDN equipment is connected to the loop, it must be configured as an S loop to ensure proper call handling.

Press ADD and enter the first or second SPID assigned to the loop.

If there are two SPIDs already assigned to the loop, ADD will not appear until one is removed.

Press REMOVE to clear a SPID.

Note: SPIDs are not required for profile 2 (ETSI) programming.

## # of B-channels



Installer password required

Press CHANGE to select the number of B-channels that are associated with the SPID: 1 or 2.



**Tip** - *When you order an ISDN service package that supplies two B-channels, you may receive one or two SPIDs from your service provider. If you receive one, it usually means you will configure the SPID to use two B-channels. If you receive two, it usually means you will configure each SPID with one B-channel. Check with your service provider if you are not sure about the proper configuration.*

## Network DNs



Installer password required

Press  to display the DNs which are used with the SPID.

Press **ADD** and enter the appropriate number to assign additional Network DNs to the SPID.

The Compact ICS can have a maximum of 32 Network DNs for the system. There is no limit to the number of Network DNs for each SPID, but you cannot exceed the limit of 32 Network DNs for the system.

If the Network DN you try to enter is already assigned to a SPID and its call type is Both, you will not be able to assign the DN again.

If the Network DN you enter is already assigned to a SPID and its call type is Voice or Data, it will be automatically programmed with the unused call type. For example, if the DN has Call type set to Voice in the previous SPID assignment, it will be automatically set to handle Data calls when the same DN is added to the other SPID.

## Call type



Installer password required

Press **CHANGE** to select the call type of the Network DN: Voice, Data, or Both.

**CHANGE** will not appear if the Network DN is already in use by the system and the call type will be automatically programmed with the unused call type. For example, if the DN has Call type set to Voice in a previous SPID assignment, it will be automatically set to handle Data calls when the DN is entered the second time.



**Tip** - *If your service provider does not specify the call type for each Network DN, it is probably available for both voice and data. Check with your service provider if you are not certain about the proper configuration.*



## D-packet servc



Installer password required

Press  to view and program D-packet service for S, T, or NT-loops. You can have two D-packet service configurations for each BRI Card.

## D-packet servc



Installer password required

Press CHANGE to turn D-packet service for this loop on (Y) or off (N).

## Lp201



Installer password required

Select the S loop (for BRI-ST cards) or LT loop (for BRI-U2 or BRI-U4 cards) that supports the D-packet service.

Press CHANGE to move through a list of the loops which are available on this card. If only one loop is available, you will not see CHANGE.

## TEIs



Installer password required

Press  to view and program the Terminal Endpoint Identifiers (TEIs). Each TEI is supplied by your service provider and is associated with an ISDN D-channel packet device.

## No TEIs on loop



Installer password required

Press ADD to program up to eight TEIs to this loop.

## Sampling



Installer password required

Press **CHANGE** to select the sampling used by an S loop:

- **Fixed:** if two or more S-interface devices use the loop and the length of the loop is less than 200 m (650 ft), select Fixed.
- **Adaptve:** if two or more S-interface devices use the loop and the length of the loop is greater than 200 m (650 ft), select Adaptve.

If one S-interface device is using the loop, the length of the loop can be up to 1000 m (3,250 ft) and the rate should be set to Adaptve.

The BRI Card must be disabled under Module Status in Maintenance before you can change this setting. You can change the setting if the card has not yet been installed in the ICS slot.

## DNs on Loop 201



Installer password required

Press  to view and program the ISDN DN assigned to the loop.

## Assign DNs



Installer password required

Press  and enter the ISDN DN you wish to assign to this loop, or press **SCAN** to move through a list of DN's already assigned to the loop.

The display shows **Availabl**, **Assigned** (assigned to this loop), **\*Lnnnn\*** (assigned as the default DN of another loop) or **Lnnnn** (assigned to another loop).

Press **LIST** to move through the all the ISDN DN's on the system one by one. The default range of ISDN DN's is 73-79.

Press **CHANGE** to assign the DN to the loop or to remove it.

## Loop DN



Installer password required

Press CHANGE to move through the ISDN DNs you have assigned to the loop. This will assign the main ISDN DN to the loop. You can also set Loop DN to **None**.



# I-RAD

The internal remote access device (I-RAD) allows you to see and change programming for the ICS using a computer equipped with remote administration software and a modem. Once you have configured the ICS for remote administration, you can call the ICS on an incoming line, connect to the I-RAD, and then program or troubleshoot the ICS using the computer.

To set up remote administration:

1. If the Feature Cartridge does not have the I-RAD enabled, turn it on by entering software keys. (If you do not see the Auto reporting programming under the System Programming heading, the I-RAD is not enabled.)  
See *Software Keys* on page e242. for instructions for obtaining and entering the keys.
2. Create a remote package with the Remote admin setting set to Y(Yes). When the package is assigned to a line, it allows remote administration.  
See *Remote access* on page 220.
3. Assign the remote access package to the line used for calling the ICS from your computer. This permits the line to be used for remote administration.  
See *Remote access* on page 220.
4. Verify that the I-RAD password used by the ICS is the same one you use with your remote administration software. Change the password, if necessary.  
See *IRAD pswd* on page 191..
5. To test the I-RAD feature, call the line you configured for remote access from a telephone and transfer to the I-RAD using one of the methods described in *Connecting to the I-RAD on page 254*. If you hear a high-pitch modem tone, the I-RAD is working and accessible.

## Connecting to the I-RAD

A personal computer equipped with remote administration software and a modem can connect with the I-RAD using one of the following methods:

- call someone on the Norstar system and have him or her enter the feature code that transfers your call to the I-RAD (☎ 8 1 7). You can also be transferred using ☎ 8 1 7 when someone has called you from the Norstar system.
- using a touch-tone telephone or modem, call the system using an Auto Attendant feature, enter the DISA DN and appropriate COS password, or the Auto DN. You can then enter the Remote Administration feature code (☎ \* \* 7 2 3).
- using a touch-tone telephone or modem, call the system on an auto-answer line and enter the Remote Administration feature code (☎ \* \* 7 2 3).
- call the incoming line that has been programmed to answer with the I-RAD after a set number of rings (see Alarm reporting on page 229).

You can connect to a Compact ICS that does not have the I-RAD enabled using the transfer to IRAD feature code ☎ 8 1 7 only. This allows you to enter the software keys to enable the I-RAD remotely. A remote access package must be applied for the line and you must have the IRAD password. When you have been transferred, the only programming heading available to you is Software Keys, which will allow you to enable the feature remotely and set up other methods of access.

You will still need to enter the Installer password to begin a remote programming session (☎ \* \* 2 6 6 3 4 4), and the remote administration software requires your system's I-RAD password.

The I-RAD is also used to automatically transmit alarm codes to a remote location. See Alarm reporting on page 229 for more information.

# Testing

After your system has been installed and programmed, test it to verify that the equipment is functioning properly.

- Verify all wiring and connections to make sure they are correct and secure.
- Use Module status in Maintenance to verify that all modules are enabled.
- Use Port/DN status in Maintenance to verify that all devices and lines are enabled and idle.
- Test each Norstar telephone by placing a call, verifying the quality and clarity of all connections, checking the indicators, and programming and using a memory button.
- Test the I-ATA by placing a call to the analog device connected to the I-ATA port. Verify that the device detects ringing. Verify the quality and clarity of the connection. Place a call from the device to verify dialing.
- Test each external line by placing a call and verifying the quality and clarity of the connection.
- Use the procedures in the user cards or installation documentation to test all optional equipment such as peripherals.
- If you have programmed any of these Norstar features, test them:
  - Routing
  - System Speed Dial
  - Restriction filters
  - Class of Service
  - Services





# Troubleshooting

These troubleshooting procedures allow you to solve many problems in the Norstar system. Follow these procedures before replacing any components.



***Only qualified persons should service system.***

The installation and service of this unit is to be performed only by service personnel having appropriate training and experience necessary to be aware of hazards to which they are exposed in performing a task and of measures to minimize the danger to themselves or other persons.

Electrical shock hazards from the telecommunication network and AC mains are possible with this equipment. To minimize risk to service personnel and users, the ICS must be connected to an outlet with a third-wire ground. In addition, all unused slots must have filler faceplates installed and the system door must be locked in place at the completion of any servicing.

Service personnel must be alert to the possibility of high leakage currents becoming available on metal system surfaces during power line fault events near network lines. Risk points on the ICS are the Feature Cartridge, heatsink and power cord earth ground pin. These leakage currents normally safely flow to Protective Earth ground via the power cord.

Therefore, it is mandatory that connection to an earthed outlet is performed first and removed last when cabling to the unit. Specifically, operations requiring the unit to be powered down must have the network connections (central office lines) removed first.

Where more than one procedure is given, you should select just one.

## Getting ready

Before you begin troubleshooting, gather all the information that is relevant to your network configuration. These are:

- the *Compact ICS 6.0 Programming Record*
- records from people who use the network
- information about other hardware and non-Norstar features within the public or private network



**Tip** - Remember that you can check many of the system parameters without having to go into a programming session.

- Use Button Inquiry (   \*  ) to check the buttons on a particular telephone.

## Types of problems

The problems you encounter will likely fall into one of the following categories.

### Misunderstanding of a feature

A problem may be reported because a Norstar user is unfamiliar with the operation of a given feature. You may be able to solve the problem simply by demonstrating how to use the feature correctly.

### Programming errors

You may encounter problems caused by errors in programming. A feature may have been programmed incorrectly or may not have been programmed at all.

### Wiring connections

Wiring problems are caused by loose, unconnected, or incorrect wiring. Use the procedures in the section on Checking the hardware as a guide.

## Equipment defects

You may encounter problems caused by Norstar equipment defects. See the appropriate section for problems related to the system hardware.

## General troubleshooting procedure

1. Diagnose the trouble by determining:
  - the types of problems users have experienced
  - the frequency of the problems
  - how many telephones are affected
2. Check how a feature is being used. A problem may have been reported because of a misunderstanding about how a feature works. Confirm that the person who reported a problem understands the intended use and operation of any feature in question.
3. Check for programming errors. Check that the programming recorded in the *Compact ICS 6.0 Programming Record* is correct for the intended operation of the system, and verify that this programming has been correctly entered.
4. Run a Station set test (☞ 8 0 5). Instructions are included in the *Compact ICS 6.0 System Coordinator Guide*.
5. Check the wiring and hardware connections.
6. If the problem persists, run a Maintenance session as described in the Maintenance chapter.
7. If hardware is defective, replace it. If the trouble requires expert advice, follow your company procedure for obtaining assistance.

---

# Problems with telephones

---

## Norstar telephone has faulty buttons, display, handset or other hardware problems

1. Run a Station Set Test (  8 0 5 ). Instructions are included in the *System Coordinator Guide*.

## Norstar telephone display unreadable



### If the trouble is with a two-line display telephone:

1. Press  \* 7 .
2. Press UP or DOWN to adjust the display to the desired level.
3. Press OK.



**Tip** - *The number of contrast settings varies with the model of telephone.*

### If the trouble is with a one-line display telephone:

1. Press  \* 7 .
2. Press a number on the dialpad to adjust the display to the desired level.
3. Press .

### If the display is still unreadable:

1. Go into Maintenance in programming and disable the problem telephone.
2. Replace the problem telephone with a known working one.
3. Enable the working telephone.

## Norstar telephone dead

1. Run a Station Set Test (☎ 8 0 5). Instructions are included in the *Compact ICS 6.0 System Coordinator Guide*.
2. If more than one telephone is affected, refer to the ICS down section on page 278.
3. Check for dial tone.
4. Check the display.
5. If the problem persists, replace the telephone with a known working Norstar telephone of the same type, so that the programming is retained.
6. Check the internal wiring at both the modular jack and the distribution cross-connect. A Norstar telephone port should have between 15 and 26 V DC across the Tip and Ring when the telephone is disconnected.
7. Check the line cord.

### Running a Maintenance session to test a dead telephone

1. Run a Maintenance session to ensure that the telephone is not disabled. See *Port/DN status* on page 294.
2. Disable the port that the telephone is connected to using the heading *Port/DN status*.
3. Enable the port that the telephone is connected to using the heading *Port/DN status*.

### Replacing a telephone

In a powered-up system, an existing Norstar telephone can be replaced by a new Norstar telephone. If you use a Norstar telephone that has already been used on the system, it may have to be reprogrammed.

#### Replacing Norstar telephones of the same type

If an existing Norstar telephone is unplugged, and a new Norstar telephone of the same type is then plugged into the same jack (for example, replacing an T7208 telephone with another T7208 telephone), the new telephone acquires the programming and the internal number of the old telephone. This is normally done to replace a defective telephone.

### **Replacing Norstar telephones of different types**

If an existing Norstar telephone is unplugged, and a new Norstar telephone of a different type is plugged into the same jack (for example, replacing an T7208 telephone with an T7316 telephone), the new telephone keeps the old internal number. The new telephone receives default programming for a telephone of its type.

If the telephone being replaced has more lines than the new telephone, automatic outgoing line selection may not work with the Handsfree/Mute feature. A line must be selected manually.

### **Status of a telephone that was replaced**

The old Norstar telephone that was unplugged and replaced by a new Norstar telephone loses its programming and internal number. The old telephone internal number has been given to the new telephone and the programming has either been removed or given to the new telephone when it was plugged into the old jack. The replaced telephone (if still functional) is now treated by the system as a telephone not previously in service.

## **Emergency telephone dead**

1. Verify that the power indicator on the ICS is not lit.
2. Verify that there is no dial tone at the emergency telephone.
3. Check that the external line and emergency telephone connections have been made correctly.
4. Ensure that the emergency telephone is not faulty by connecting it directly to the external line 002 and listening for dial tone.
5. Verify that the ICS has a Loop Start Trunk Cartridge installed.
6. Verify that there is dial tone on line 002 of the ICS.
7. Replace the ICS.

---

# Problems with lines

---

The troubleshooting problems listed here focus on trouble with making calls or using lines. For problems which are specific to BRI lines, see *Problems with BRI service* on page 274.

## Calls cannot be made (but can be received)

1. Press   .
2. Press a line button.
3. If an incorrect line number or name appears (or if neither appears) on the Norstar telephone display, check the programming settings.  
**OR**  
If the correct line number or name appears on the Norstar telephone display, make sure the external lines are properly cross-connected.
4. Check the restrictions that are applied to the set and to the lines at the set.
5. Check that the dialing mode is consistent with that used by the central office (CO).
6. Run a Maintenance session and verify that the module in which the Trunk Cartridge is installed in is not disabled or unequipped using the heading Module status.
7. Run a Maintenance session and disable the appropriate ports using the heading Port/DN status. For charts showing external line port number defaults, refer to Installing the hardware.
8. Enable the appropriate ports using the heading Port/DN status.
9. To check the line, contact the telephone company.

## Dial tone absent on external lines

1. Use Button Inquiry (    ) to display the number of the external line you are testing.
2. Check for dial tone using a test telephone at the connections for the external line on the distribution block.
3. Make sure that a Trunk Cartridge for the line is properly installed in the ICS.
4. Refer to the section on Trunk Cartridge trouble in this chapter.
5. Run a Maintenance session to ensure that the line is not disabled. (See Port/DN Status in the Maintenance chapter.)

## Hung lines at a telephone

Line indicators that have been solid for a long time are the only visible indication that lines are hung.

### Possible problem

A line that has been redirected using Line Redirection may, under some circumstances, remain busy after a call is over. If this happens, the outgoing line for the redirection also remains busy. You can clear this kind of hung line only at the telephone that was used to redirect the line.

### Solution

1. Enter the Button Inquiry feature code (    ) at the telephone that was used to redirect the line.
2. Press the button of the redirected line.
3. Press SHOW or .
4. Press DROP or .

Both the redirected line and the outgoing line for the redirection should now be cleared.



---

## Possible problem

The supervision or Discon timer programming for the line does not match the settings for the line at the central office.

## Solution

Verify that your programming for the line matches the central office settings.

---

## Possible problem

Lines are still hung after all the above solutions have been investigated or tried out.

## Solution

For lines that are hung for any other reason, you will have to run a Maintenance session.

1. Run a Maintenance session and go to the heading **Module status**.
2. Disable and enable the affected Trunk Cartridge.

Follow the procedures in the Troubleshooting overview and the Installation check sections before proceeding.

# Auto-answer line rings at a Norstar telephone

## Possible problem

You configured a loop start trunk as auto-answer but the installed hardware does not support disconnect supervision. (In this case, the symptom would be accompanied by the Alarm 62 code symptom.)

## Solution

Reconfigure the trunk as manual answer.

**OR**

Replace the Trunk Cartridge with one that provides disconnect supervision.

---

## Possible problem

The line is configured as auto-answer and unsupervised.

## Solution

Reconfigure the line as manual answer.

**OR**

Reconfigure the line as supervised.

---

## Possible problem

The line is not equipped for disconnect supervision at the central office.

## Solution

Reconfigure the trunk as manual answer.

---

## Possible problem

The Discon timer setting for the Trunk Cartridge in Trunk/Line data does not match the setting for the line at the central office.

## Solution

Reconfigure the Discon timer to match the setting at the central office.

# Prime telephone gets misdialed calls

## Possible problem

The digits sent by a switch at a central office or in the private network did not match any Received number, the Auto DN, or the DISA DN. The call has been routed to the prime telephone for the incoming trunk.

## Solution

1. Verify that the switch is sending the correct number of digits for the Received number length defined in your system.
2. Verify all the digit strings that the switch should be sending.

3. Check that you have defined the corresponding Received number for every target line in your system.
4. Make sure that the published telephone numbers for your network are correct.

## **Selected line shows 'Not in service' or 'Not available'**

### **Possible problem**

The line has been disabled for maintenance purposes.

### **Solution**

Enable the line.

**OR**

If the line will be out of service for some time, configure another line to replace it on the telephone.

## **Selected line pool shows 'No free lines'**

### **Possible problem**

If this happens often, there are not enough lines in the line pool to serve the number of line pool users.

### **Solution**

Enter programming and move less-used loop start trunks from other line pools into the deficient line pool.

# Problems with the I-ATA

---

The problems listed here focus on trouble with the I-ATA and the analog device connected to it.

## Calls do not ring and caller does not receive busy tone

1. Verify that the ringer of the attached analog device is turned on.
2. Check the ringer volume.
3. Verify that calls can be answered even when the device does not ring.
4. Replace the analog device with a single-line analog telephone and check for ringing.
5. Check for ringing at the wiring connection block using a single-line analog telephone.
6. Check wiring from the connection block to the attached analog device.
7. Check the requirements of the analog device to see if it is compatible with the I-ATA specifications (see specifications on page 329).

## I-ATA is always busy

1. Remove the attached analog device from the I-ATA line and make a call to the I-ATA from a Norstar telephone. If the line is not busy, the analog device may be faulty. If the line is busy, check the wiring.
2. Ensure that the analog device is not faulty by connecting it directly to an external line and verifying that it functions correctly.
3. Check the internal wiring at the modular jack and the distribution cross-connect. The I-ATA port should have about 31 Vdc across the Tip and Ring when the telephone is disconnected.
4. Check the requirements of the analog device to see if it is compatible with the I-ATA specifications. Refer to *Specifications* on page 329.
5. Run a maintenance session to ensure the I-ATA is not disabled. Refer to *Port/DN status* on page 294.

## **Calls cannot be answered (or dial tone is not present when making calls)**

1. Check that the I-ATA connections have been made correctly.
2. Replace the analog device with a single-line analog telephone and check for dial tone.
3. Ensure that the analog device is not faulty by connecting it directly to an external line and checking for dial tone.
4. Check that the I-ATA is not busy by making a call to it from a Norstar telephone. If it is busy, remove the analog device and check for busy.
5. Check the internal wiring at the modular jack and the distribution cross-connect. The I-ATA port should have about 31 Vdc across the Tip and Ring when the telephone is disconnected. The voltage should drop when the analog telephone is connected and a call is attempted.
6. Check the requirements of the analog device to see if it is compatible with the I-ATA specifications. Refer to *Specifications* on page 329.

## **Calls cannot be made (but dial tone is present)**

1. Ensure that the analog device is not faulty by connecting it directly to an external line and making a call.
2. Ensure the dialed number is not restricted by call restrictions.
3. Check if the ICS is detecting dialing by listening to the dial tone. Dial the first digit of an internal telephone DN and check that dial tone is removed. If you still hear dial tone, the ICS is not detecting the dialed digit.
4. Determine if the problem is associated with the wiring by connecting the analog device directly at the modular jack or the distribution cross-connect by the ICS. If calls can be made with this connection, the problem may be with the internal wiring.
5. Check the internal wiring at the modular jack and the distribution cross-connect. The I-ATA port should have about 31 Vdc across the Tip and Ring when the telephone is disconnected. The voltage should drop when the analog telephone is connected and a call is attempted.
6. Check the requirements of the analog device to see if it is compatible with the I-ATA specifications. Refer to *Specifications* on page 329.

# Problems with optional equipment

## Auxiliary ringer

1. If the auxiliary ringer is used for Schedules (Night, Evening, or Lunch schedule), ensure that Schedules is activated from the control telephone.
2. Check the wiring between the auxiliary ringer generator and the ringing device. Refer to the auxiliary ringer wiring chart.
3. Check the wiring between the auxiliary ringer generator and the distribution block.

### Auxiliary ringer wiring

Feature	Pin
Auxiliary ring (Make)	50 (Violet-Slate)
Auxiliary ring (Common)	25 (Slate-Violet)

4. Ensure that the auxiliary ringer contacts are operating properly by checking with an ohmmeter across the auxiliary ringer pin contacts. Refer to the auxiliary ringer wiring chart.
5. Check that the auxiliary ringer pin contacts are programmed to operate in conjunction with any or all of the features in the auxiliary ringer programming chart.

### Auxiliary ringer programming

Feature	Programmed in	
Auxiliary ringer: Lines	Lines	Trunk/Line data
Auxiliary ringer: Sets	Terminals&Sets	Capabilities
Service Modes	Services	Ringing service

The maximum current carrying capability of the Norstar auxiliary relay contacts is 50 mA dc. They are designed to operate with the auxiliary ringer generator, or equivalent.

## External paging

1. Use the Button Inquiry feature (    ) to verify the feature of a programmable memory button.
2. Check the wiring between the 50-pin connector and the paging amplifier or between the connections shown in the external paging wiring chart.

### External paging wiring

Feature	Pin
Page out (Tip)	50 (Violet-Slate)
Page out (Ring)	25 (Slate-Violet)
Page (Make)	49 (Violet-Brown)
Page (Common)	24 (Brown-Violet)

3. Test external paging (    ) to ensure that it is working. The nominal output signal from the Norstar ICS is 100 mV rms across 600 Ω.

## Music on Hold/Background Music trouble

Although Music on Hold and Background Music are separate features, they share the same wiring and customer-supplied music source.

1. Ensure that the proper feature access code (    ) is turned on. Adjust the volume using the volume control bar.
2. Use the Button Inquiry feature (    ) to verify the feature on a programmable memory button.
3. If there is trouble with Music on Hold, check the music settings in programming.

### Music programming

Feature	Programmed in	
Backgrnd music: Y	System prgming	Featr settings
On hold: Music	System prgming	Featr settings

4. Check the wiring between the music source and the 50-pin connector. See the wiring charts in the Installation section.
5. Ensure that the music source is turned on, is operational, and the volume control is set properly.
6. Any music source with a low-output impedance (for example, less than 3,300 ohms) can be connected. The output level must be less than one volt.



---

# Problems with Trunk Cartridges

---

Check first for user configuration problems, then wiring and programming errors before replacing Norstar equipment.

## Trunk Cartridge trouble

1. Check that the cartridge is properly inserted in the ICS.
2. Run a Maintenance session to ensure that the cartridge is not disabled.

### If the problem persists:

1. If AC power is present and the LED indicator on the ICS is off, see the section on ICS down on page 278.

Refer to the Installation chapter for information about replacing components.

# Problems with BRI service

Each LED on front of a BRI-ST or BRI-U Card corresponds with a loop, or indicates an overall state of the BRI connections.

## BRI Card indicators

LED status	T, S, or U-NT loop	S or U-LT loop
on	normal operation	
off	no synchronization with ISDN network	no synchronization with TE
all flashing	Card is not recognized by ICS (not configured in Hardware as a valid BRI loop). Refer to <i>All the LEDs on a BRI Card are flashing</i> on page 275	
bottom LED only flashing	ICS is downloading firmware to the card; card is new to the ICS, or Feature Cartridge has been upgraded	

## The BRI card is connected to the ISDN network (U-loop) but the LED for one of more loops is not lit

### Possible problem

The physical connection or configuration for the network connection is not correct (no Layer 1).

### Solution

1. Verify the wiring from the network to the distribution block.
2. Verify the wiring from the distribution block to the ICS.
3. Use a Meridian 2500 set to test for data on the BRI trunk.
4. Test the network connection by connecting Bellcore standard terminal equipment (TE) directly to the network.
5. Verify that the loop is provisioned.
6. Verify that the loop is properly configured, including the proper loop type, SPIDs, and Network DNs.
7. Disable and re-enable the BRI Card.
8. Disable and enable the module for the Card.

## **“Out of service” is displayed when a BRI line is selected (LED for loop is lit)**

### **Possible problem**

The loop is configured incorrectly. Layer 1 is present but Layers 2 and 3 are not working.

### **Solution**

1. Verify that the SPIDs and Network DNs are programmed correctly in Hardware.
2. Verify that the loop and lines are provisioned.

## **All the LEDs on a BRI Card are flashing**

### **Possible problem**

The card is not configured properly.

### **Solution**

1. Verify that the loop is properly configured, including the proper loop type, SPIDs, and Network DNs.

---

### **Possible problem**

The card is not recognized by the ICS.

### **Solution**

1. Verify that an Expansion Cartridge with Clocking, or Clocking Cartridge is installed in the ICS.
2. Replace the card with another card of the same type.

## **Caller hears one ring and then a fast busy signal when placing a call on a BRI line**

### **Possible problem**

CACH or EKTS, which are not supported by Compact ICS, is included in the ISDN services package.



### **Solution**

1. Contact your service provider and ensure that CACH or EKTS are not part of the ISDN services package. These services must be turned off at the switch.
2. Verify that the Network DNs have been programmed correctly, and verify the numbers with your service provider.

# Problems with the NT1

The table gives the meaning of the indicators found on the stand alone NT1 manufactured by Nortel. Other models or makes of NT1 may have different indicators. For more information about the NT1, see the ISDN chapter.

## NT1 status indicators

Indicator	State	Meaning
	off	power is unavailable
	on	power is available
	flashing	system is on backup power
S or T	off	normal operation
	on	no synchronization with terminal equipment
	flashing	high error rate
U	off	normal operation
	on	no synchronization with the network
	flashing	high error rate
	off	normal operation
	on	test in progress
	flashing	self-test failed

# ICS down

If AC power is present and the indicator light on the ICS is off, replace the fuse in the ICS (see illustration on next page).

1. Disconnect all central office and station lines from the ICS. Power down the ICS by unplugging it.



***Your Norstar system requires connection to a grounded outlet.***

To prevent possible injury from voltage on the telephone network, disconnect all central office and station lines before removing plug from the electrical outlet.

2. After powering down the ICS, use fingernails or screwdrivers to pinch the tabs on the fuse drawer and remove it from the ICS. The cables can easily and safely be pushed aside to reach the fuse drawer.
3. Remove the fuse from the left-hand compartment and discard. This is NOT the one labeled spare fuse.
4. Insert the new fuse into the left-hand compartment.
5. A spare fuse is located in the right-hand compartment of the fuse drawer. This fuse is labeled as a spare fuse.
6. If there is no spare fuse, you will have to obtain a replacement.



***Replace with the same type of fuse.***

For continued protection against risk of fire, replace only with the same type and rating of fuse (250 V, 3.15 A).

7. Replace the fuse drawer in the ICS and restore power to the system.
8. Connect the central office and station line connectors.

## Changing a fuse

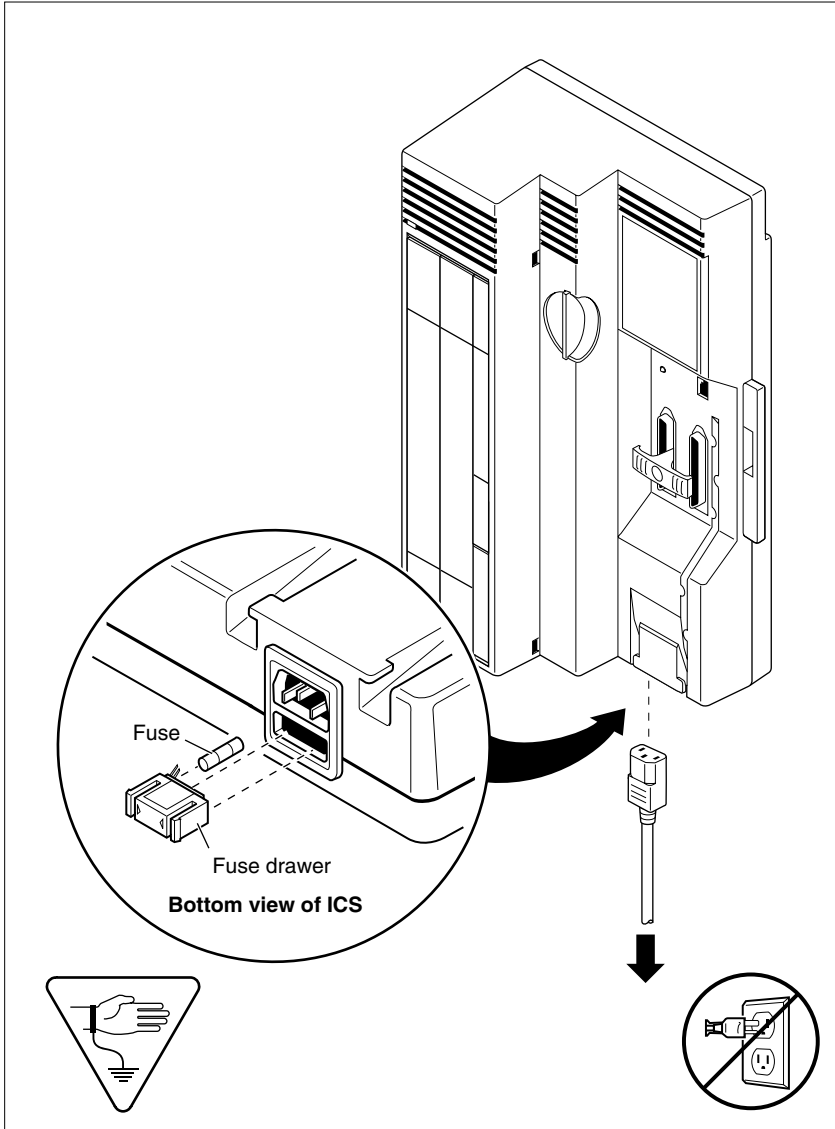

# Problems for network or remote users

---

## Remote feature code gets no response

### Possible problem

A Norstar user has called into another Norstar system and is trying to activate a remote feature but gets no response after dialing the feature code.

### Solution

1. If a COS password is needed for remote access, make sure the user has entered the appropriate password.
2. Make sure that the remote caller is dialing the feature code correctly. Use the asterisk (\*) character, followed by the feature code, to activate a remote feature.  
Do not use  for accessing features on a remote Norstar system.
3. Ensure that the remote user is dialing tones, not pulses once the call is answered.
4. Make sure an appropriate remote package is in use for the incoming line.
5. Check the restrictions for the remote package used with the incoming line.

## Dialed number gets ringback and the wrong person

### Possible problem

The digits sent by a switch at a central office or in the private network did not match any Received number, the Auto DN, or the DISA DN. The call has been routed to the prime telephone for the incoming trunk.

### Solution

1. Verify that the switch is sending the correct number of digits for the Received number length defined in your system.
2. Verify all the digit strings that the switch should be sending.



3. Check that you have defined the corresponding Received number for every target line in your system.
4. Make sure that the published telephone numbers for your network are correct.

## Dialed number gets stuttered dial tone instead of ringback

### Possible problem

The remote caller has tried to reach a Norstar target line, but has reached a trunk with DISA instead. Alternatively, the Norstar system has mapped incoming digits onto the DISA DN.

### Solution

1. Verify all the digit strings that the switch should be sending.
2. Check that you have defined a corresponding Received number for every target line in your system.
3. Check that you have defined the correct DISA DN for your system.
4. Make sure that the published telephone numbers for your network are correct.

## Dialed number gets dial tone instead of ringback

### Possible problem

The remote caller has tried to reach a Norstar target line, but has reached the Norstar system instead. Norstar has mapped the incoming digits onto the Auto DN.

### Solution

1. Verify all the digit strings that the switch should be sending.
2. Check that you have defined the corresponding Received number for every target line in your system.
3. Check that you have defined the correct Auto DN for your system.
4. Make sure that the published telephone numbers for your network are correct.

## Dialed number gets busy tone

### Possible problem

The target line that the incoming digits map onto is busy, and there is no prime telephone for the incoming trunk.

### Solution

For maximum call coverage, make sure that you configure a prime telephone for every incoming trunk.

## Dialed number does not get through

### Possible problem

The digits sent by a switch at a central office or in the private network did not match any Received number, the Auto DN, or the DISA DN. There is also no prime telephone assigned for the incoming trunk. In this case, the caller may hear overflow tone from the Norstar system or a recorded message from the originating switch.

### Solution

1. Configure a prime telephone for every incoming trunk.
2. Verify that the switch is sending the correct number of digits for the Received number length defined in your system.
3. Verify all the digit strings that the switch should be sending.
4. Check that you have defined a Received number for every target line in your system.
5. Make sure that the published telephone numbers for your network are correct.

## Possible problem

The Norstar system did not receive some or all of the incoming digits.

## Solution

1. Check that the system hardware is receiving signals properly.
2. Verify that the switch is sending the correct number of digits for the Received number length defined in your system.
3. If the switch at the far end is sending pulse signals, make sure they are being sent at the proper rate. (Pulse digits must be 300 ms or more apart for Norstar to receive them.)

## Dialed DISA number gets ringback instead of stuttered dial tone

### Possible problem

The remote caller has dialed a DISA number, but has instead reached a target line, or has been routed to the prime telephone for the auto-answer trunk. The Norstar system has mapped the incoming digits from a switch onto a target line, or has been unable to map the digits anywhere.

### Solution

1. Verify that the switch is sending the correct number of digits for the Received number length defined in your system.
2. Verify all the digit strings that the switch should be sending.
3. Check that you have defined the correct DISA DN for your system.
4. Make sure that the published telephone numbers for your network are correct.

## Dialed DISA number gets dial tone instead of stuttered dial tone

### Possible problem

The remote caller has dialed a DISA number, but has reached the Norstar system instead. The Norstar system has mapped the incoming digits from a switch onto the Auto DN.

### Solution

1. Verify that the switch is sending the correct number of digits for the Received number length defined in your system.
2. Verify all the digit strings that the switch should be sending.
3. Check that you have defined the correct DISA DN for your system.
4. Make sure that the DISA DN and Auto DN are different enough to prevent misdialing.
5. Make sure that the published telephone numbers for your network are correct.

## DISA user gets overflow tone when entering COS password

### Possible problem

The remote caller may have entered an invalid password.

### Solution

Check the Administration programming under COS passwords and verify that the caller has a valid password.

---

### Possible problem

The remote caller may have entered an asterisk (\*) as one of the six digits.

### Solution

Instruct remote callers to enter their COS password correctly: enter six digits.

---

## Possible problem

The remote caller may have entered a number sign (#) as one of the six digits.

## Solution

Instruct remote callers to enter their COS password correctly: enter six digits. The number sign (#) may be entered after the sixth digit, but is not required.

---

## Possible problem

The remote caller may have waited more than 15 seconds between entering digits.

## Solution

Instruct remote callers to enter their COS password correctly: enter six digits, and do not pause too long between digits.

---

## Possible problem

The caller may be dialing from a rotary-dial telephone or from a push-button telephone that uses pulse signaling.

## Solution

Inform remote callers that they must dial from a push-button telephone that uses DTMF, also known as touch-tone signaling.

## Dialed feature code gets overflow tone

### Possible problem

The remote caller does not have access to that feature.

### Solution

1. If the call came in on a trunk with DISA, check the Class of Service that is associated with the remote caller's COS password. If it is too restrictive, modify the remote package assigned to the COS password, or assign another COS password that is more suitable.
2. If the call came in on a trunk without DISA, check the remote package that you assigned to the incoming trunk. Make sure that it gives the appropriate access to the remote caller.

---

### Possible problem

The feature code is not valid.

### Solution

1. Make sure that remote callers have a correct listing of the features that are programmed for remote access.
2. Ensure that remote callers are dialing the feature code correctly. Press  followed by the feature code to activate a remote feature.

---

### Possible problem

The caller may be dialing on a rotary-dial telephone or on a push-button telephone that uses pulse signaling.

### Solution

Inform remote callers that they must dial from a push-button telephone that uses DTMF, also known as touch-tone signaling.

---

## Dialed feature code gets busy tone

### Possible problem

A resource that the remote feature uses may currently be in use. For example, a remote caller trying to use the paging feature would get a busy tone if the auxiliary speaker were being used at the time.

### Solution

If repeated attempts to use the remote feature produce a busy tone, there may be a malfunction in a resource that the feature uses. Check that the remote feature hardware is functioning normally.

## Line pool access code gets overflow tone

### Possible problem

If the published line pool access code is valid, the remote caller does not have access to that line pool.

### Solution

If the incoming trunk answers with DISA, give the remote caller a COS password that permits access to that line pool.

**OR:** Change the remote package for the incoming trunk so that it permits access to that line pool.

**OR:** Give the remote caller a line pool access code that is permitted within the Class of Service on the incoming trunk.

---

### Possible problem

The published line pool access code is invalid and there is no prime telephone for the auto-answer trunk.

### Solution

1. Make sure that the published line pool access codes are correct.
2. Check that the line pool access codes have been entered correctly under Access codes in System programming.

---

## Possible problem

The caller may be dialing from the network on a rotary-dial telephone or on a push-button telephone that uses pulse signaling.

## Solution

Inform remote callers that they must dial from a push-button telephone that uses DTMF, also known as touch-tone signaling.

## Line pool access code gets ringback

### Possible problem

The published line pool access code is invalid, and the system has routed the call to the prime telephone for the incoming trunk.

### Solution

1. Make sure that the published line pool access codes are correct.
2. Check that the line pool codes have been entered correctly under Access codes in System prgrming.

## Line pool access code gets busy tone

### Possible problem

There are not enough lines in the line pool to serve the number of users.

### Solution

If the line pool contains loop start trunks, enter Trunk/Line Data and move less-used loop start trunks from other line pools into the deficient line pool.



## Dialed number gets no response

### Possible problem

The remote caller, after accessing a line in a line pool, may have started dialing before the far end was ready to receive digits.

### Solution

Instruct remote callers to wait until they hear feedback before entering any digits.

---

### Possible problem

There may be a malfunction in the line that the remote caller accessed.

### Solution

If the problem is persistent, check that all lines in the affected line pool are functioning normally.

---

### Possible problem

There may be a malfunction in the system that the caller is trying to reach.

### Solution

Inform the operators of the system at the far end that the dialed number is not getting through.



# Maintenance

## Maintenance overview

A Norstar Maintenance session helps you diagnose problems that may occasionally arise within the Norstar system.

The Maintenance section of programming has eight headings.

<code>System version</code>	displays the version number of the system processor.
<code>Port/DN status</code>	allows you to check and change the status of ports in your system.
<code>Module status</code>	allows you to check and change the status of modules in your system.
<code>Sys test log</code>	displays a list of test results, event messages, and alarm codes.
<code>Sys admin log</code>	displays a list of system initializations, configuration sessions, invalid password attempts and password changes.
<code>Provisioning</code>	allows you to place BRI loops and lines in and out of service.
<code>Tests</code>	allows you to test the connection between the ICS and telephones, and the connection between a BRI Card and the network.
<code>Remote monitr</code>	allows a technical specialist from a remote location to monitor the Norstar system. It is not a regular part of system installation or maintenance.

You can perform a Maintenance session from any working T7316, M7310 or M7324 telephone. Only one person at a time can access a Maintenance session. Photocopy the Maintenance records found at the end of this chapter, and keep a pencil handy to record important information.

## Beginning a Maintenance session

1. Release all calls on your telephone.
2. Press          which is the same as          . The display shows **Password:**.
3. Enter the Installer password. The display shows **Terminals&Sets**. Three triangular indicators ► appear on the vertical display between the rows of buttons.
4. Place the programming overlay over the buttons pointed to by the indicators ►.
5. Press  until the display shows **Maintenance**.

---

# System version

---

System version allows you to note the version number of the system processor (SP) software, which resides in the Feature Cartridge.

The SP version number can be used to determine whether you have the latest software release, and to trace a software fault if one occurs. For instance:

- SP version number can indicate a Feature Cartridge incompatibility with your system
- SP and telephone version numbers can indicate a telephone version incompatibility
- SP and functional terminal version numbers can indicate a functional terminal incompatibility.

## Checking the version of the system

To check the version number, start with the display reading **Maintenance:**

1. Press . The display shows **System version**.
2. Press . The display shows the version number of the SP.
3. Write the SP version number on the appropriate Maintenance record.

# Port/DN status

Port/DN status allows you to:

- identify any device or line connected to the system
- check the version number of a device (an analog terminal adapter, for example) for compatibility with the system
- check the state of a device or line (for example, idle or busy)
- disable or enable a device
- determine which port number corresponds to each DN
- determine the port number of a malfunctioning device
- determine if a malfunctioning device is incompatible with the Norstar system
- disable a device before replacing it



**Tip** - *You cannot disable the Norstar telephone from which you are accessing the Maintenance session. If you try to do this, a message appears on the display and you hear an error tone. If you want to disable that particular telephone, conduct the Maintenance session from another Norstar telephone.*



**Pick a suitable time to disable devices.**

Do not disable devices when many people are using the Norstar system. Wait until after regular office hours.

Do not enable or disable ports during the first two minutes after Startup programming.

If you do so, incorrect ports may be enabled or disabled. To recover from this, disable then enable the affected modules using Module status.

Port/DN status allows you to check lines and devices on the system. Although the following procedures describe how to check devices, you can use the same procedures to check lines.

Lines can only be disabled in Module status.

## Identifying a device connected to the system

Start with the display reading `System version:`

1. Press . The display shows `Port/DN status`.
2. Press . The display shows `Show port:`.
3. Enter the port number of the device, or press `DN`, then enter the directory number of the device. The display shows port information, as illustrated in the sample displays. This identifies the DN (internal number) associated with the B1 channel.
4. Press `DEVICE` to see device information, as illustrated in the sample displays. If the device has version information, you will be able to see the information by pressing .
5. If there is more than one device attached to a port (for example, a Norstar telephone and a central answering position (CAP) module or a Busy Lamp Field), press  while the information is on the display to show the device and press  to see the add-on devices.
6. Press `>B2` to display the device connected to the B2 channel.
7. Press  until the display shows `Port/DN status`.

## Displays

### Sample device identification display

```
P104:24
DEVICE >B2 STATE
```

This sample display indicates that port 104 is associated with the DN 24. Press `DEVICE` to see the device attached to the port.

```
P225:1P225
VERSN TEI STATE
```

This sample display indicates that port 225 is associated with loop 225. Press `TEI` to see any terminal endpoint identifiers associated with the loop. `TEI` will appear only for U-NT, T, or S-loops.

P104:7324  
VERSH

This sample display indicates that an M7324 telephone is attached to port 104.

The following table lists some of the device types that may appear on the Norstar device identification display.

### Explanation of device type

Display	Explanation
7100	M7100 telephone or T7100 Business Series Terminal
7208	M7208 telephone or T7208 Business Series Terminal
7310	M7310 telephone or T7316 Business Series Terminal
7324	M7324 telephone
1: CAP1	First CAP module attached to an M7324 telephone
2: CAP2	Second CAP module attached to an M7324 telephone
IATA	Internal analog terminal adapter
IRAD	Internal remote access device
BLF	Busy Lamp Field

## Checking the version number of the device

From the Norstar device identification display:

1. Press **VERSH** (if it is available) when the device information for a port is displayed. The display shows the version number of the device.
2. Write this number on the appropriate Maintenance record.
3. Press **OK** to return to the Norstar device identification display from the display showing the version number.
4. Press  to see information about the next port number  
**OR**  
 Press  to see information about the previous port number.



## Checking the state of the device

From the Norstar DN identification display:

1. Press STATE. The display shows one of the states listed in the following table.  
If you want, you can disable or enable the device (see the procedures in this chapter).
2. Press OK to return to the device identification display.

### How the device state is shown on the display

Display	State of device
Busy DISABLE      OK	The device is in use.
Disabling... OK	The device is being disabled.
Enabling... OK	The device is being enabled.
Idle DISABLE      OK	The device is not in use.
Unequipped DISABLE      OK	There is no device connected to that port.
Disabled by user ENABLE      OK	The device has been disabled by someone running a Maintenance session.
Disabled by sys. ENABLE      OK	The device has been disabled by the system because it is faulty or because a test is running.
Not available DISABLE      OK	There is no state available.

## Disabling a device



***Give notice that you are disabling equipment.***  
Make sure you inform people that you are going to disable their devices because all calls on the affected line or set will be dropped.

To disable immediately when the display indicates the device is busy:

1. Press **DISABLE**. The display shows **Disable at once?**
2. Press **YES**. The system prompts the device user and disables the device in one minute (or immediately, if the device is idle). Press **NO** to leave this display without disabling the device.

## Displays

The following table show examples of the sequence of messages that might appear on a telephone when you disable a device.

### Examples of display messages

Please hang up  
Maintenance test

Occurs on a busy telephone before  
disabling

48 seconds  
until disconnect

Please hang up

In Maintenance

Occurs after disabling

## Enabling the device

When the display shows you that the device is disabled:

1. Press **ENABLE**. The display briefly shows **Enabling...** The device is immediately enabled and the display shows **Idle**.



**Tip** - *The display may briefly show **Enabling...**, then either **Disabled by sys.** or **Disabled by user**. In this case, the system is waiting to enable the module. This may occur after someone has run a Maintenance session and used **Module status**. You cannot enable the device until its module has been enabled.*

*Individual lines cannot be disabled in Port/DN status. To disable a Trunk Cartridge, see **Module status**.*

## Returning to the beginning

From the display showing the state of the device:

1. Press **OK**.
2. Press  until the display shows **Port/DN status**.

---

# Module status

---

Module status allows you to:

- check the number of Trunk Cartridges in the ICS
- disable or enable a ICS cartridge
- clear a hung line by disabling and enabling the affected Trunk Cartridge.

## Looking at the module inventory

Start with the display showing **Port/DN status**:

1. Press . The display shows **Module status**.
2. Press . The display shows **Show module:**.
3. Enter the module number. Modules 1 and 2 are located inside the ICS. If you choose module 1, the display shows how many telephones are connected to the ICS. If you choose module 2, the display shows the number of Trunk Cartridges connected to the ICS.



**Tip** - *Norstar devices may occupy both the B1 and B2 channels. This may increase the number of devices indicated on the module inventory display.*

## Checking the number of Trunk Cartridges attached to a module

Start from the module inventory display, which shows the number of Trunk Cartridges connected to the module you chose (for example, **KSU: 2 cards**).

1. Press **CARD**. If there is a Trunk Cartridge in a slot, the display shows that four lines are connected (for example, **Card 1: 4 lines**).
2. Press  or  to check for a Trunk Cartridge in the other slot.
3. Press **MODULE** to return to the module inventory display.

## Checking the state of a module

Start from the module inventory display, which shows the number of Trunk Cartridges connected to the module you chose (for example, KSU: 2 cards).

1. Press STATE. The state of the module is shown on the display. Some examples of this display are shown on the following page.
2. Press OK to return to the module inventory display.

### How the module or cartridge state is shown on the display

Example	State of module or cartridge
3 sets busy DISABLE OK	There are three devices in use that are connected to the module or cartridge.
2 ports busy DISABLE OK	There are two ports in use that are connected to the module or cartridge.
4 lines busy DISABLE OK	There are four lines in use that are connected to the module or cartridge.
Disabling... OK	The module or cartridge is being disabled.
Enabling... OK	The module or cartridge is being enabled.
Unequipped DISABLE OK	There is no cartridge connected to that port.
Disabled by user ENABLE OK	The module or cartridge has been disabled from a Maintenance session.
Disabled by sys. ENABLE OK	The module or cartridge has been disabled by the system because it is faulty or because there is a test running.
Updating state...	The system is verifying the state of the module or cartridge.

## Checking the state of a cartridge

Start from the display that shows the number of lines connected to the Trunk Cartridge you chose (for example, **Card 1: 4 lines**).

1. Press **STATE**. The display shows the state of the cartridge. Some examples of this display are shown in the previous table.
2. Press  or  to check the other Trunk Cartridges.
3. If required, you can disable or enable the cartridge. (See the procedures in the following two sections.)
4. Press **OK** to return to the display showing how many lines are connected to the Trunk Cartridge.

## Disabling a module or its cartridges



### *Use Page feature prior to disabling.*

Use the Page feature to inform people that you are about to disable a module. Mention that they may experience delays in the performance of their devices.

From the display showing the state of the module or cartridge:

1. Press **DISABLE**. The display shows **Disable at once?**
2. Press **YES**. The system disables the module or cartridge in one minute (or immediately, if the status is idle). Press **NO** to leave this display without disabling the device

## Enabling a module or its cartridges

From the display showing the state of the module or cartridge:

Press **ENABLE**. The display briefly shows **Enabling....** The module or cartridge is immediately enabled. The display then shows the state of the module or cartridge.

## Returning to the beginning

From any display showing the state of the module or cartridge:

1. Press **OK**.
2. Press **Heading** until the display shows **Module status**.

---

# System test log

---

The System test log shows you a list of diagnostic test results, audits, event messages, and alarm codes. By using this feature you can:

- check the items in the log
- check the current alarm (if there is one)
- check when each item in the log occurred
- check the number of consecutive occurrences of an event or an alarm
- erase the log

The System test log holds a maximum of 20 items. You should check and record these items at regular intervals. Erase the log after dealing with all the items.

## Checking the items in the log

Start with the display reading **Module status**:

1. Press . The display shows **Sys test log**.
2. Press . The display shows **Items in log:**. (If there is no log entry, the display shows **Items in log:0** and returns to **Sys test log**.)
3. Press  or . The display shows a log item.
4. Write down the item on the System test log record on page 327.
5. If the log item is an event message or an alarm code, refer to the Event messages section or the Alarm codes section in this chapter.
6. Repeat steps 3, 4, and 5 until you have recorded all the items.

## Checking the current alarm

If you want to check the highest severity alarm quickly before viewing all the log items, start with the display reading **Items in log:**.

1. Press **ALARM**. The display shows an alarm code.  
If there is no current alarm, **ALARM** does not appear on the display.
2. Press **OK** to return to the display **Items in log:**.



All alarms are recorded as items in the System test log.

## Checking when each item in the log occurred

Start with any display showing a log item:

1. Press TIME. The display briefly shows the date and time.
2. Write the date and time on the System test log record.

## Checking the number of consecutive repetitions of an event or alarm

If REPEAT appears under a display showing a log item:

Press REPEAT. The display shows the number of consecutive times the event or alarm occurred.

## Erasing the log

Start with the display reading `Items in log:`

1. Press ERASE. The display shows `Erase log?`
2. Press YES.

If no new items have been added since the list was entered, the log is erased and the display shows `Log erased`.

**OR**

If new items have been added since the list was entered, the display briefly shows `Cancel-new items` and returns to the display `Items in log:`

3. Press  to return to `Sys test log`.

---

# System administration log

---

The System administration log keeps a record of administrative events such as system initialization, configuration sessions in which a change was made, invalid password attempts, and password changes. By using this feature you can:

- check the items in the log
- erase the log
- check when each item in the log occurred

The System administration log holds a maximum of ten items. Erase the log after dealing with all the items.

## Checking the items in the log

Start with the display reading `Sys test log`.

1. Press  `Next` . The display shows `Sys admin log`.
2. Press  `Show` . The display shows `Items in log:`. (If there is no log entry, the display shows `Items in log:0`.)
3. Press  `Next`  or  `Back` . The display shows a log item.
4. Write down the item on the System administration log record on page 328.
5. Repeat steps 3 and 4 until you have recorded all the items.

## Checking the current alarm

Start with the display reading `Items in log:`.

1. Press `ALARM`. The display shows an alarm code.  
If there is no current alarm, `ALARM` does not appear on the display.
2. Press `OK` to return to the display showing `Items in log:`

## Checking when each item in the log occurred

Start with any display showing a log item:

1. Press TIME. The display briefly shows the date and time.
2. Write the date and time on the System administration log record.

## Erasing the log

Start with the display reading **Items in log:**.

1. Press ERASE. The display shows **Erase log?**
2. Press YES. If no new items have been added since the list was entered, the display shows **Log erased**.

**OR**

If new items have been added since the list was entered, the display briefly shows **Cancel-new items** and returns to the display **Items in log:**.

3. Press  to return to **Sys admin log**.

---

# Provisioning

---

Provisioning applies only to BRI loops and lines. It allows you to place loops and lines in or out of service, either before or after the BRI Cards have been installed in the ICS.

When you provision a loop, ISDN terminals on the loop can be used to make outgoing calls or receive incoming calls (S or U-LT loop), or lines are available for use by the devices attached to the system (T, S, or U-NT loop). When you are configuring a T, S, or NT loop, you must also provision each line on the loop to place the lines in service.

## Cd1-KSU

The card type of an installed card appears with the setting. If no card has been installed, you can change the card type under **Hardware**.

- Press  to display the loops found on the card.
- Press **ADD** to provision the loop, or press **REMOVE** to take the loop out of service.
- If lines on the loop are busy, the display will ask if you still want to remove the loop from service. Press **YES** to go ahead. Both lines on the loop are de-provisioned.

## L001

If the loop is configured as a T, S, or U-NT loop, press  and  to display the individual lines. There are no lines associated with an S or U-LT loop.

- Press **ADD** to provision the line, or press **REMOVE** to take the line out of service.
- If line is busy, the display will ask if you still want to remove it from service. Press **YES** to go ahead.

# Alarm codes

The Norstar ICS generates alarm codes after system disconnections or after certain anomalies in system operation. All alarm codes appear at the Alarm telephone and in the System test log of a Maintenance session. For a complete description of alarm and event codes, you may order an *Alarm and Event Code Manual* from your service provider. The following figure shows an alarm code appearing on a Norstar Alarm telephone display.

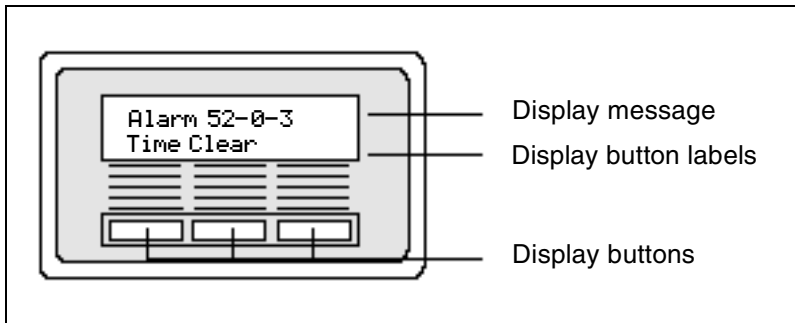

**Tip** - *The Alarm telephone is assigned in Featr settings of System programming.*

*Alarms have a higher severity than events. Attend to alarm codes before event messages.*

*Alarm codes can be automatically transmitted to a remote location in addition to appearing on the Alarm telephone. See Alarm reporting in the Programming chapter for more information.*

## If you see an alarm code

1. Write the alarm code in the System test log record on page 327.
2. Determine the cause of the alarm from the following table.
3. Follow Alarm troubleshooting procedures in this chapter.
4. Press **TIME** to see when the alarm occurred.

5. Press **CLEAR** to clear the alarm.

An alarm code may not be displayed until two minutes after it has been triggered. If the ICS is without power when the alarm is triggered, the alarm code is not displayed until two minutes after the power is restored to the ICS. For a complete list of Norstar alarms, consult the *Norstar Alarm & Event Code Manual*.

## Displays

Example display	Meaning	Possible causes
Alarm: 10	All ICS devices disconnected.	The last device on Norstar bus 1 (port numbers 101-124) has been removed. A 25-pair cable was disconnected from the ICS. There is an internal ICS fault.
Alarm: 37 ABBCDD	An error has occurred in the download of a protocol to a BRI Card. A: the maintenance index of the BRI BB: a code describing the nature of the error C: the current download state DD (appears when the error is limited to one protocol): the two-character product identifier of the protocol	The BRI Card is not properly installed.
Alarm: 52 X Y	A Trunk Cartridge has been disconnected.	The Trunk Cartridge is not properly installed.
Alarm: 61 X Y	Incompatible Trunk Cartridge	Trunk Cartridge Y on port X cannot operate with the Trunk type assigned to it in configuration.
Alarm: 62 X Y	Unsupported auto-answer setting (Loop Start TCs)	Trunk Cartridge X on port Y does not support the auto-answer setting.

Example display	Meaning	Possible causes
Alarm: 63 Z	No available DTMF receivers	DTMF receivers are busy, not working properly, or have not been installed.
Alarm: 74	The ICS is unable to synchronize with the ISDN network.	No clocking cartridge is installed.
Alarm: 75	Clocking for BRI lines is no longer synchronized with the network connection.	The digital link has been disconnected.

"X" = DS-30 port number (1-8)

"Y" = Trunk Cartridge number (numbered from left to right)

"Z" = Trunk port number

## Alarm troubleshooting

Refer to the previous table before following these procedures.

### Alarm: 10

1. Check to see if there is a device connected to the ICS (that has a port number beginning with the number 1).
2. If there are no devices connected to the ICS, connect one and then press CLEAR.
3. If there are any devices connected to the ICS, check all the wiring associated with the devices.
4. Refer to the section in the Troubleshooting chapter entitled ICS down.

### Alarm: 37

1. Check that the BRI Card is properly installed.
2. Remove and re-install the BRI Card.
3. If the alarm persists, replace the BRI Card with another BRI Card of the same type.

### **Alarm: 52-X-Y**

1. Check all connections to the Trunk Cartridge.
2. Check that the proper Trunk Cartridge is inserted in the appropriate slot of the ICS.
3. Remove and re-install the Trunk Cartridge.
4. If the alarm persists, replace the Trunk Cartridge with another Trunk Cartridge of the same type.

### **Alarm: 61-X-Y**

1. Check that the proper Trunk Cartridges are inserted in the proper slots of the ICS.
2. Enter programming and look under the Trunk/Line data heading. Check that the Trunk Cartridge type is correctly configured. Check that the Trunk mode and Answer mode settings do not conflict for every line connected to Trunk Cartridge Y. If Trunk mode is set to unsupervised, Answer mode must be set to Manual.

**OR**

Install a Trunk Cartridge in slot Y that matches the type of trunk you have configured.

### **Alarm: 62-X-Y**

1. Check that the proper Trunk Cartridges are inserted in the proper slots of the ICS.
2. Enter programming and look under the Trunk/Line data heading. Check that the Trunk Cartridge type is correctly configured. Check that the Trunk mode and Answer mode settings do not conflict for every line connected to Trunk Cartridge Y. If Trunk mode is set to unsupervised, Answer mode must be set to Manual.

### **Alarm: 63-Z**

Enter programming and look under Lines in the Trunk/Line data heading. Check that the Answer mode is correct for all the loop start lines.



## **Alarm: 74**

Ensure an Expansion Cartridge with Clocking or Clocking Cartridge is installed in the ICS.

## **Alarm: 75**

Check the connection to your ISDN service provider.

# Event messages

---

Event messages appear as items in the System administration log or the System test log of the Maintenance session. Most of these event messages can only be caused by an unusual combination of events, and should rarely occur.

Each event is assigned a severity number. An S preceding this number, S4 for example, may appear in the event message. S9 is the most severe. If the Log is full, new event messages with a higher severity number replace existing event messages of a lower severity. For this reason, you should check event messages at regular intervals. You can then deal with all messages before they are replaced.

For a complete list of Norstar events, consult the *Norstar Alarm & Event Code Manual*.

## Dealing with event messages

For every event message that you see:

1. Record the event on the appropriate Maintenance record.
2. Consult the next section entitled Significant event messages.
3. To see if the event caused the Norstar system to automatically restart, consult the subsequent section entitled Complete list of event numbers.

## Significant event messages

The table on the next page lists event messages that are relevant to Maintenance activities. The time that the message is recorded is also provided.

## Displays

Event message		The event message is recorded when...
EVT196	S4	there was a software error on the built-in modem
EVT197	S4	system operation is slow or there was a software error with the auto-attendant feature
EVT210-YYYZ	S4	Loopback test YYY on Trunk Cartridge Z has been started
EVT211-YYYZ	S4	Loopback test YYY on Trunk Cartridge Z has been stopped
EVT220-21	S4	the System administration log has been cleared by the DN (21 in this example)
EVT221-21	S4	the System test log has been cleared by the DN (21 in this example)
EVT222-21	S5	the DN (21 in this example) enters the debugging facility that is password protected
EVT255	S9	administered mode is not supported by the cartridge plugged into the slot
EVT268-07	S8	Restriction filter 07 has lost data due to a fault in the system memory
EVT269-21	S8	the Line/set restriction for the DN (21 in this example) has lost data due to a fault in the system memory
EVT299	S1	the system powers up after a power failure
EVT373	S5	the ICS restart diagnostic tool has been activated
EVT400	S9	Startup programming is performed using <input type="checkbox"/> <input type="checkbox"/> * <input type="checkbox"/> * <input type="checkbox"/> S <input type="checkbox"/> T <input type="checkbox"/> A <input type="checkbox"/> R <input type="checkbox"/> T <input type="checkbox"/> U <input type="checkbox"/> P
EVT407	S2	there are no more codes for Speed Dial numbers
EVT408	S2	there is no more memory for Speed Dial codes
EVT416-21	S3	an invalid password has been entered by the DN (21 in this example)

<b>Event message</b>		<b>The event message is recorded when...</b>
EVT418	S7	a DN change is successful
EVT419	S2	the time setting has been changed
EVT421	S8	a DN change failed
EVT422-21	S6	a length change by the DN (21 in this example) has been requested
EVT423-21	S6	an individual DN change has been requested by the DN (21 in this example)
EVT425	S6	an attempt has been made to add a DN or access code which is already in use by the system
EVT448	S8	the system has started to copy data to a range of telephones
EVT449	S4	the system has completed copying data to a range of telephones
EVT451	S5	a remote user made three unsuccessful attempts to enter the installer password to access the Remote monitoring feature
EVT452-21	S4	a programming password has been changed by the DN (21 in this example)
EVT453-21	S4	a programming session has been initiated by a DN (21 in this example)
EVT454-21	S5	an invalid password has been entered by the DN (21 in this example) while attempting to start a programming session
EVT799-00040B57		a call processing error on the fourth BRI loop; see <i>Event message 799</i> on page 317
EVT822	S8	Alarm code 63 is sent because there are no DTMF receivers for an incoming call

## Event message 799

Event message 799 indicates a call processing error has occurred on an ISDN line. The event number is followed by a number representing the line or loop number, and a code for the type of error.

EVT799-XXXX YY57      In this example, the error has occurred on line XXX and the error code is 0A.

<b>Error code</b>	<b>Meaning</b>
01	Internal software error. Cannot acquire the B-channel from the B-channel arbitrator.
02	Internal software error. There is no free line available for the call.
03	A call that is not on the B-channel has been attempted. These kind of calls are part of EKTS service, which is not supported by this version of the software. Check with your service provider to make sure your package does not include EKTS service.
04	Internal software error. Failed to instantiate on the chain.
05	Internal software error. Activation procedure failed.
06	Internal software error. Index conversion failed.
07	Unexpected digits on a Manual answer mode line. Configuration of the ICS and the network connection may not match.
08	Internal software error. Cannot seize central office (CO) line on a BRI connection.
09	Cannot get vterm (virtual terminal) from the Vterm Server.
0A	Central office did not respond to the SPID initialization request.
0B	Central office has rejected the SPID. Verify your SPID information programmed under Hardware and with your ISDN service provider.
0C	Internal software error. Already instantiated on the chain.

## Displays

You should rarely see any event messages that are not described in the section entitled Significant event messages. If you do see one of these event messages, the Norstar system has followed its normal recovery from an unusual combination of system events. Although the problem is not a serious one, repeated occurrences of the event number should be reported as soon as possible.

As a result of some events, the Norstar system automatically restarts itself. The table on the next two pages lists all the event numbers and tells you which of these events are associated with Norstar system restarts.

Most of these events are recorded in the System test log. The few exceptions to this are recorded in the System administration log, as indicated.

<b>Event Message</b>	<b>System Restart</b>	<b>Event Message</b>	<b>System Restart</b>
101-106	Yes	285-298	Yes
107	No	299	No
108-112	Yes	362-363	No
113	No	373	No
114-116	Yes	400 (Admin log)	Yes
117	No	401-411	No
118-120	Yes	412-423 (Admin log)	No
121-123	No	424-425	No
124-125	Yes	426-430	Yes
126-129	No	431	No
130	Yes	432	Yes
131-132	No	433	No
133-134	Yes	441-451	No
135-136	No	600-602	Yes
137	Yes	603-613	No
138-150	No	614	Yes

---

<b>Event Message</b>	<b>System Restart</b>	<b>Event Message</b>	<b>System Restart</b>
151	Yes	615-629	No
152	No	630	Yes
160-164	No	631-646	No
170-173	No	800-802	No
196-211	No	803	Yes
220 (Admin log)	No	804-807	No
221-222	No	808	Yes
223 (Admin log)	Yes	809	No
224	Yes	810	Yes
225-228	No	811-820	No
229 (Admin log)	Yes	823	Yes
230-235	No	824-825	No
245-248	No	883	No
250-256	No	900	No
260-271	No	940-943	No
280-283	No	950-989	No

# Tests

Norstar allows you to run a test which verifies the integrity of the installation wiring for Norstar sets. In addition, you can evaluate the transmission quality of a BRI loop through your service provider using a loopback test.

## Loopback test

The loopback test for BRI lines loops the incoming BRI payload back to the local exchange (service provider) for evaluation of the transmission quality. Loopback tests should be conducted only with guidance from the service provider. The results from the tests are returned to the service provider.

You can run loopback payload tests simultaneously on multiple loops or multiple cards. The loop must be provisioned to perform the test. All calls on the card you are testing will be dropped at the start of a loop payload test.

## Starting and stopping a payload loopback test



***All calls on a BRI loop are dropped when you start loopback test.***

While the loopback test is in progress, the BRI lines go out of service. There is no warning from the system. Pick an appropriate time to do a test and warn users that they will lose any calls in progress.

Start with the display reading **Tests**.

1. Press . The display shows **BERT-DN tests**.
2. Press . The display shows **Loopback tests**.
3. Press . The display shows **Show Module**.
4. Press  the display shows **Cards on KSU**. If you want to run a test on the second card, or go to the next step.



5. Press . The display shows the first S or T loop (if you are looking at a BRI-ST Card) or first NT-loop (if you are looking at a BRI-U Card). Payload loopback tests are not available for S-loops.
6. Press  until you see the loop you want to test.
7. Press . The display shows **Payload loopback**.
8. Press **START** to begin the test. The display shows the test name followed by **running**.  
You can exit programming or move on to other programming tasks while the test is running, or begin a test on another loop.
9. Press **STOP** to end the test.



# Usage Metrics

## Hunt groups

Installer password required

This feature gives you statistical information about hunt group calls.

From **Usage Metrics**, start with the display showing **Hunt Groups**.

1. Press  the display shows **Show Group:**
2. Enter the group number. The display shows **H91 metrics**.
3. Press  to display the date the information was last cleared.
4. Press  the display shows **TotalCalls:**

The displayed value is the total number of calls received by the hunt group, up to a maximum value of 99999.

5. Press  the display shows **Ans:**

The displayed values are the number of calls that were answered up to a maximum value of 99999 and the percentage of answer calls versus total calls up to a maximum value of 999.

6. Press  the display shows **Avg ans: . sec.**

The displayed value is the average time in seconds that it took to answer a call, up to a maximum value of 999.

7. Press  the display shows **Abndn:**

The displayed values are the number of calls that were abandoned up to a maximum value of 99999 and the percentage of abandoned calls versus total calls up to a maximum value of 999.

8. Press  the display shows **Busy:**

The displayed values show the number of times the hunt group was busy up to a maximum value of 99999 and the percentage of busy call versus total calls up to a maximum value of 999.

9. Press  the display shows **Overfl:**

The displayed values show the number of calls that were sent to the overflow position up to a maximum value of 99999 and the percentage of overflow calls versus total calls up to a maximum value of 999.

10. Press  the display shows **Avg Q: sec**

The displayed value is the average time in seconds the call waited in the queue, up to a maximum value of 999.



# Maintenance records

Maintenance records are tables used to record information you have obtained while running a Maintenance session.

Before you begin, photocopy the tables in this section.

## Recording information on the Maintenance records

To use the following records, do the following:

1. While running a Maintenance session, enter the information on a photocopy of the appropriate Maintenance record.
2. Return the completed records to your Norstar distributor.

## Version number record

The Maintenance session tells you the software versions of the System Processor (SP), and devices connected to the Norstar system. Use the following table to record these version numbers when you run a Maintenance session. You can check the SP version number under the heading System version. Device version numbers are found under the heading Port/DN status.

**Version numbers**

<b>System version</b>	<b>Port/DN status</b>
SP:	Device:
	Device:
	Device:
	Device:
	Device:
	Device:
	Device:
	Device:
	Device:
	Device:
	Device:
	Device:
	Device:
	Device:
	Device:
	Device:
	Device:
	Device:
	Device:
	Device:
	Device:
	Device:
	Device:
	Device:
	Device:
	Device:
	Device:
	Device:
	Device:
	Device:
	Device:
	Device:
	Device:



## System administration log record

You can check under the Sys admin log heading to find a list of administrative events performed on Norstar. Use this table to record these log items when you run a Maintenance session.

### System administration log

Sys admin log		
Log item	Time of log item	Number of repetitions
	:	
	:	
	:	
	:	
	:	
	:	
	:	
	:	
	:	
	:	
	:	
	:	
	:	
	:	
	:	
	:	
	:	
	:	
	:	
	:	
	:	
Time and date that log was checked	:	/ /



# Specifications

## Norstar system

### Service tone cadences

<b>Tone</b>	<b>Cadence (seconds)</b>
Busy	0.5 on / 0.5 off
Expensive route	0.3 on / 0.3 off (3 bursts)
Overflow	0.25 on / 0.25 off
Ringback	2.0 on / 4.0 off
Confirmation	1.0 on / 1.0 off (3 bursts followed by no tone)
Recall	1.0 on / 1.0 off (3 bursts followed by steady tone)
Ring splash	0.2 on (1 burst)

### Power specifications

<b>Characteristic</b>	<b>ICS</b>
Voltage V AC (nominal)	110-120*
Current A rms (max)	1.9
Frequency Hz (nominal)	50-60
Crest factor	4.0
Fuse	250 V, 3.15A

\*Connection to ac power rated greater than 120 V ac nominal requires an approved cord set for that voltage range.

## Telephone loop specifications

Characteristic	Value
Loop resistance	64 $\Omega$ (300 m of 0.5 mm wire or 975 ft of 24 AWG wire)
Loop length	300 m (975 ft) without station auxiliary power supply 1200 m (3900 ft) with station auxiliary power supply
Minimum voltage at telephone	11 V dc
Current at telephone (idle)	45 mA nominal
Current at telephone (active)	80 mA maximum

## Electrical requirements

Characteristic	Spec/Value
Electrostatic discharge ICS and telephones	IEC 801-2 2nd Edition, level 3 maximum of 8 kV with a 300 $\Omega$ /150 pF probe
Connectors	IEC 801-2 2nd Edition, level 2
Radiated immunity	Bell Canada TAD 8465 (operation in fields of up to 5V/m over the frequency range of 100kHz to 1GHz)
Conducted immunity	Bell Canada TAD 8465 (operation with common mode injected voltage of up to 3V RMS over the frequency range of 150 kHz to 30 MHz)

**Environmental requirements**

<b>Characteristic</b>	<b>Spec/Value</b>
Operating temperature range	0°C to 50°C (32°F to 122°F) IEC. 68-2-1 Tests Ad and IEC. 68-2-2, Method A
Storage temperature range	-50°C to 70°C (-58°F to 158°F) IEC. 68-2-1 Test Ab and IEC. 68-2-2 Test Bd
Humidity above 34°C (93°F) at 40°C (104°F)	5% to 95% (non-condensing) <52 mbar of water vapor pressure IEC. 682-2-3 Test Ca

**Internal analog terminal adapter (I-ATA)**

<b>Characteristic</b>	<b>Spec/Value</b>
Battery voltage	-31 V dc $\pm$ 10%
Maximum loop length	900 m (3000 ft)
Minimum loop current	25 mA
Current limit	39 mA
Ringing voltage at T/R	50 Vrms
Maximum ringing load	2 REN
Ringing frequency	20 Hz
Ring trip time limit	150 ms

**ISDN network synchronization**

<b>Characteristic</b>	<b>Spec/Value</b>
Free run clock accuracy	$\pm$ 32 ppm
Network synchronized clock accuracy	$\pm$ 5 ppm



# Glossary

## A

**AbsorbLength:** A setting that determines how many of the digits in a destination code will not be dialed by the system. AbsorbLength is assigned under Destination codes in Services.

**access code:** Different sequences of characters used to gain access to these Norstar features: Line pools, Call park, external lines, Direct-Dial telephone, Auto DN, and DISA DN.

**alarm code:** A number that appears on the alarm telephone display, informing you that the ICS has detected a fault in the system.

**Alarm telephone:** A telephone that is designated to receive reports of Norstar system problems. This function is usually assigned to a prime telephone, but this can be changed under Feature settings in System programming.

**Analog Terminal Adapter (ATA):** A device that permits the connection of analog telecommunication devices such as fax machines, answering machines, and single line telephones to the Norstar system. Programmed defaults for the ATA are automatically assigned by the Norstar system.





**ANSI:** American National Standards Institute.

**Answer button:** A telephone button with an indicator that is used to monitor another telephone. The answer button indicates incoming calls destined for the other telephone. Someone working at a telephone with answer buttons (an attendant, for example) can receive all ringing and visual indication of incoming calls for other telephones, and answer those calls when necessary.

One telephone can have up to eight Answer buttons. An Answer button is automatically assigned to a telephone when that telephone is assigned an Answer DN.

**Answer DN:** The internal or directory number (DN) of a telephone that is monitored by an Answer button. You can assign up to four Answer DNs to a telephone under Line Access in Terminals and Sets programming.

**Auto Attendant:** Gives your system the ability to answer calls with a recorded message and then prompt caller to leave a message, or enter a code or extension number for further access or services.

**Autobumping:**    

A feature that determines what the system does with new Call Log items when your Call Log is full. When Autobumping is on, a new log entry causes the oldest entry to be deleted. If Autobumping is off, your Norstar system does not log calls when your log is full.

**Autodial button:** A memory button that, if programmed, provides one-touch dialing of external or internal numbers.

**Autolog options:**    

A feature that allows you to select the type of calls that are stored in your Call Log. You can choose to log calls that were not answered by anyone within the system, to log calls that were unanswered at this telephone but answered elsewhere in the system, to log all calls answered and not answered at this telephone, or to not have calls automatically logged.

**Automatic Dial:** A feature that allows you to dial without having to pick up the handset or select a line. You must have a prime line to use Automatic Dial. Automatic Dial is assigned under Dialing options in Terminals and Sets programming.

**Automatic Handsfree:** A feature which automatically activates Handsfree operation when you make or answer a call. Automatic Handsfree is assigned under Handsfree in Terminals and Sets programming.

**Automatic Hold:** A feature that automatically places an active call on hold when you select another line. Automatic Hold (Full AutoHold) is assigned in Lines programming.

**Automatic Privacy:** See Privacy.

**Automatic Daylight Saving Time:** A feature that switches the system to standard or daylight saving time at pre-programmed dates. It is turned on or off under Daylight time in System programming.

### **Automatic Telephone**

**Relocation:** A feature that allows a telephone retain its personal and system programming when it is plugged into a different Norstar modular jack. Automatic Telephone Relocation is enabled under Set relocation in System programming.

**auxiliary ringer:** A separate external telephone ringer or bell which can be programmed to ring when a line or a telephone rings. An auxiliary ringer may be programmed to ring only when the system is in a particular schedule. Programming of an auxiliary ringer is done in Services programming after the feature has been enabled under Capabilities in Terminals and Sets programming.

**AWG:** American wire gauge.

## **B**

**B channel (Bearer channel):** An ISDN standard transmission channel used for voice or data transmission.

**Background Music:** A feature that allows you to hear music from the speaker of your Norstar telephone. It is available only if a music source has been attached to the ICS and the feature has been enabled under Feature settings in System programming.

**Basic password:** A one- to six-digit password that prevents unauthorized access to the most commonly-used telephone settings. The Basic password can be assigned and changed in Passwords programming.

**Basic Rate Interface (BRI):** An ISDN interface that uses two B channels and a D channel (2B+D).

**Bearer channel:** See B channel.

**Business series terminals** These terminals were developed to replace the Norstar M-series terminals. Therefore, their functionality closely parallels the M-series terminals.

**busy lamp field (BLF):** A device with a liquid crystal display (LCD) panel of indicators that shows the status of up to 24 telephones in the Norstar system. The BLF attaches to the M7310 telephone.

**button caps:** Interchangeable plastic caps that fit over the buttons of Norstar telephones. They are used to indicate the features programmed onto each programmable memory button. Button caps are either pre-printed or have clear windows that allow you to insert labels.

**Button Inquiry:**   

A feature that allows you to check the function of each programmable button on your Norstar telephone.

## C

### Call Duration timer: 7 7

A feature that allows you to see how long you spent on your last call or how long you have been on your present call.

### Call Forward: 4

A feature that forwards all the calls arriving at your telephone to another telephone in your Norstar system. To have calls forwarded outside the system, use Line Redirection.

**Call Forward No Answer:** A feature that forwards all calls arriving at your telephone to another designated telephone in your Norstar system after a specific number of rings. Call Forward No Answer is assigned under Capabilities in Terminals and Sets programming.

**Call Forward On Busy:** A feature that forwards all calls at your telephone to another designated telephone if your telephone is busy. This feature is assigned under Capabilities in Terminals and Sets programming.

**Call Forward Override:** An automatic system feature that allows you to call someone and ask them to stop forwarding their calls to you.

### Call Information: 8 1 1

Call Information allows you to display information about incoming calls. For external calls, you can display the caller's name, telephone number and the line name. For an internal call, you can display the name of the caller and their internal number. You can obtain information about ringing, answered, or held calls.

### Call Information Trunk Cartridge:

A Trunk Cartridge that allows you to connect loop start trunks with Call Information capability to the Norstar system.

### Call Log:

 8 1 2

Enter your Call Log to view a record of incoming calls. The log could contain the following information for each call: sequence number in the Call Log, name and number of caller, long distance indication, indication if the call was answered, time and date of the call, number of repeated calls from the same source, and name of the line that the call came in on. See Autobumping, Autolog options, and Call Log for further information.

### Call Park: 7 4

With this feature you can place a call on hold so that someone can retrieve it from any other telephone in the Norstar system by selecting an internal line and entering a retrieval code. The retrieval code appears on the display of your telephone when you park the call. You can park up to nine calls on the system at one time.

**Call Park Callback:** See Callback.

**Call Park prefix:** The first digit of the retrieval code of a parked call. This digit cannot conflict with the first digit of any existing DN's, Line Pool access codes, the Direct-dial digit, or the external line access code. The default Call Park prefix digit is "1". It may be set to none, in which case Call Park is disabled. Call Park prefix is assigned under Access codes in System programming.

### Call Pickup Directed: 7 6

A feature that allows you to answer a call ringing at any Norstar telephone by entering the internal number of that telephone before taking the call. Call Pickup Directed is enabled under Feature settings in System programming.

**Call Pickup Group:** See Pickup Group.

**Call Queuing:** [e] [8] [0] [1]

If you have several calls waiting at your telephone, you can invoke the Call Queuing feature to answer them in order of priority. Priority is given to incoming calls, followed by callback and camped calls.

**Callback:** If you park, camp, or transfer a call to another telephone and it is not answered there, it will ring again at your telephone. How long the system will wait before Callback occurs is set under Feature settings in System programming.

**Camp-on:** [e] [8] [2]

A feature that allows you to reroute a call to a telephone even if all the lines on that telephone are busy. To answer a camped call, use Call Queuing or select a line if the camped call appears on your telephone. Priority is given to queued calls over camped calls.

**Camp timeout:** The length of a delay before a camped call is returned to the telephone that camped the call. The length of delay is set under Feature settings in System programming.

**CCR:** See Custom Call Routing

**Central answering position**

**(CAP):** An M7324 telephone that has been designated as a CAP under CAP assignment in System programming. The CAP provides backup answering and can be used to monitor the telephones within a Norstar system.

**Central answering position (CAP) module:** A module connected to an M7324 telephone and provides 48 additional buttons that can be used as autodial buttons or feature buttons. A maximum of two CAP modules can be connected to a single M7324 telephone.

**Class of Service (COS):** The set of Norstar features and lines available to the user for a call. The Class of Service for a call is determined by the restriction

filters and remote access packages assigned to the telephone in Lines programming. The Class of Service for a call can be changed by entering a six-digit Class of Service password. (Internal users cannot change their access to features with a COS password, only their restriction filters.) Class of Service and Class of Service passwords are assigned in Passwords programming. See Remote Access.

**Class of Service password:**

[e] [6] [8]

A six-digit code that allows you to switch from your current Class of Service to one that allows you to dial numbers prohibited by your current Class of Service.

**Cold start:** When all system programming is lost. This can happen because you have entered the Startup feature code (\*[\*] [S] [T] [A] [R] [T] [U] [P]), or after a major event (such as an extended power failure).

**Conference:** [e] [3]

A feature that allows you to establish a three-person call at your Norstar telephone.

**Contrast Adjustment:**

[e] [\*] [7]

Allows you to set the contrast level of your telephone display.

**control telephone:** A control telephone can place the lines for which it has responsibility in or out of a ServiceMode. The direct-dial telephone is a control telephone for directing calls to the extra direct-dial telephone. A telephone is made a control telephone and has lines assigned to it under Common settings in Services programming.

**COS:** See Class of Service.



**cursor:** A short horizontal line that appears on the Norstar telephone display to indicate that characters can be entered using the dialpad.

**Custom Call Routing:** Answering and transferring calls can be taken over by CCR. The system answers the call and plays a recorded greeting. Callers are given options to route their call by pressing a digit.

## D

**D channel (Data channel):** An ISDN standard transmission channel that is packet-switched and is used for call setup, signalling and data transmission.

**Data channel:** See D channel.

**Data terminal:** A device such as a modem that can be used to transfer data instead of sound over a telephone network. You cannot use Norstar programming to set up such devices. See the documentation that accompanies the device.

**Date:** See Show Time or Time and Date.

**defaults:** The settings for all Norstar features when the system is first installed. Settings are changed from their defaults in programming. In this manual, default settings are shown in **bold** text.

**Delayed Ring Transfer (DRT) to prime:** After a specified number of rings, this feature transfers an unanswered call on an external line, to the prime telephone associated with that line. This feature is activated under Feature settings in System programming.

**Destination code:** A two- to seven-digit number that the system interprets and then translates into the digits that

you want dialed out. Both the code and its associated dialed digits are assigned under Routing service in Services programming.

**Dialing restriction:** See Restriction filter.

**Dialing Modes:** 

This feature allows you to set the dialing mode of your telephone. Norstar supports three dialing modes: Automatic Dial, Pre-Dial, and Standard Dial. All three modes support on-hook dialing (meaning you can dial a call without picking up the handset). The special features of the Automatic and Pre-Dial modes are available only when you dial on-hook.

**Direct-dial:** A feature that allows you to dial a designated telephone in your Norstar system with a single digit. Each telephone in the system can be assigned to the direct-dial telephone. The direct-dial telephone is established under Direct-dial in System programming. Telephones are assigned to the direct-dial telephone under Capabilities in Terminals and Sets programming.

**Direct-dial #:** A digit used system-wide to call the Direct-dial telephone. The digit is assigned under Access codes in System programming.

**Direct-dial number:** The digit used to call the direct-dial telephone.

**Direct Inward System Access**

**(DISA):** The feature that allows remote users dial directly into the Norstar system and use Norstar features. Callers will hear stuttered dial tone and will be required to enter a Class of Service password to gain access to the system. See Remote Access.

**Directed Pickup:** See Call Pickup Directed.

**Directory number (DN):** A unique number that is automatically assigned to each telephone or data terminal. The DN, also referred to as an internal number, is often used to identify a telephone when settings are assigned during programming. Default DN assignments start at 21.

**DISA DN:** The received number assigned to the Norstar direct inward system access facility. If a caller dials a number that is assigned to the DISA DN, the caller hears stuttered dial tone and must enter a Class of Service password. Once the password is accepted, the caller hears system dial tone and can use Remote Access features. See Remote Access.

**Disconnect Supervision:** A setting that enables the Norstar system to detect if an external caller hangs up. Once an external caller hangs up, the Norstar system can disconnect its line. Disconnect Supervision is enabled under Trunk/Line data in Lines programming.

**Display:** A liquid crystal display (LCD) on the Norstar telephone that guides you through feature operation and programming.

**Display button:** The T7316, M7310 and M7324 telephones are each equipped with three buttons located directly beneath the display. During feature operation or programming, some or all of these buttons may be used to provide further options. If an option is available, it is shown in the bottom row of the two-line display, directly above the corresponding display button. Display buttons are represented in this manual as underlined capital, such as OK.

**DN:** See Directory number.

**Do Not Disturb (DND):**

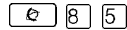

A feature that stops calls from ringing at your telephone. Only Priority Calls will ring at your telephone. A line button will flash when you receive a call, but the call will not ring.

**DTMF:** See Dual tone multifrequency.

**Dual tone multifrequency:** Two distinct telephone signaling tones used for dialing.

## E

**Emergency telephone:** A single-line telephone (also referred to as a 500/2500 telephone) that becomes active when there is no power to the ICS.

**Evening schedule:** See Schedules, and Services.

**Event message:** Event messages are stored in the system log and displayed during a Maintenance session. They record a variety of events and activities in the Norstar system.

**Exceptions:** See Overrides.

**Expansion Cartridge:** A cartridge that allows you to connect an additional eight telephones to your Norstar system.

**External call:** A call to a destination outside the Norstar system.

**External Call Forward:** See Line Redirection.

**External code:** The number you dial to get an external line. By default it is 9, but this can be changed under Access codes in System programming. You do not always need an external code. It is primarily to support the M7100/T7100 telephones and single line telephones using an Analog Terminal Adapter.

**External line:** A line on your Norstar telephone used for making calls to destinations outside the Norstar system.

**External music source:** See Music source.

**External paging:** A feature you can use to make voice announcements over an externally-mounted loudspeaker connected to the ICS. The external speaker is not a Norstar component and must be supplied by the customer.

## F

**Feature button:** Many Norstar features are invoked by pressing the Feature button followed by a feature code. The feature button is also used to exit a feature.

**Feature Cartridge:** A replaceable cartridge containing the Norstar features. The Feature Cartridge is inserted into the ICS.

**Feature code:** A number that is used to activate a particular feature.

**Feature programming:**



Allows you to program a feature code onto a memory button.

**Forward:** See Call Forward.

**Full Autohold (on idle line):** When this feature is on, if you select an available line, and then do something that selects another line, the first line is put on hold. Full Autohold is enabled under Trunk/Line data in Lines programming.

**Full Handsfree:** See Handsfree.

## G

**Group Listening:**

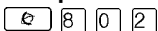

A feature that allows you to have others in your office hear a caller through your phone's speaker. The caller hears you only when you speak into the handset and cannot hear other people in the

office. You can cancel Group Listen for the current call. Group Listen is cancelled automatically when you hang up the Group Listen call.

## H

**Handsfree:**

A feature you can use to make calls without using the telephone handset. Full Handsfree is activated under Capabilities in Terminals and Sets programming. When it is activated, a Handsfree/Mute button is automatically assigned to the telephone.

**Handsfree (HF) Answerback:**

When activated, this feature automatically turns on the microphone at a telephone receiving a Voice Call so that the person receiving the call can respond without lifting the handset. It is activated under Capabilities in Terminals and Sets programming.

**Handsfree/Mute button:** See Handsfree.

**Hardware:** A section in programming that shows what equipment has been installed in the ICS. This section is accessed by the installer.

**Headset:** A head-mounted or ear-mounted telephone handset that is used instead of the hand-held handset. Headsets are not Norstar components and must be supplied by the customer.

**Held (Line) Reminder:** A Norstar telephone rings and displays the message **On hold: LINENAM** when an external call has been placed on hold for a certain period of time. The Held Line Reminder feature and Remind delay are set under Feature settings in System programming.

**HF Answerback:** See Handsfree Answerback.

**Hold button:** 

This button is used to suspend calls so that the person using the telephone can perform another task without disconnecting the caller.

**Hookswitch Flash:** See Link time.

**Hospitality** The Hospitality features allow business which use hospitality telephones, or room-based telephones, to control access, alarms, and maintenance duties through the telephones.

**Host system signaling:** Also referred to as end-to-end signaling. Norstar telephones can access a remote system or dial a number on an alternate carrier by means of host feature activation, such as Link, Pause and Run/Stop.

**Hotline:** This feature automatically calls a pre-assigned number when the telephone's handset is lifted or the Handsfree/Mute button is pressed. A Hotline number can be an internal or external number. Hotline is assigned under Capabilities in Terminals and Sets programming

**Hunt group:** The hunt groups feature allows a group of sets to be called by a single directory number ensuring that calls are easily routed to the appropriate group.

---

**I**

**I/C:** An abbreviation of intercom.

**ICS (integrated communication system):** The central hardware component in the Norstar system. The ICS has its own processor and memory, and provides a physical point of connection for the various types of devices, telephones, and cartridges used in Norstar. The ICS can function on its own as a basic system (with eight

Norstar telephones and four external lines), or be expanded to a total of 24 telephones and 8 lines.

**I-ATA:** See Internal Analog Terminal Adapter.

**Installer password:** A one-to six-digit password that prevents unauthorized access to programming. The Installer password can be assigned and changed in Passwords programming.

**internal analog terminal adapter (I-ATA):** A device built into the Norstar ICS, which permits the connection of analog telecommunication devices such as fax machines, answering machines, and single line telephones. The system has one I-ATA.

**integrated communication system:** See ICS.

**Integrated Services Digital Network (ISDN):** A digital telephone service that allows for a combination voice and data connection over a single, high-speed connection. ISDN service can operate over the same copper twisted-pair telephone line as analog telephone service.

**Intercom button:** A button that provides access to internal lines used for calls within a Norstar system and access to external lines through a line pool or external code. A telephone may be assigned zero to eight Intercom buttons. This is done under Line access in Terminals and Sets programming.

**Intercom keys:** See Intercom button.

**Internal line:** A line on your telephone dedicated to making calls to destinations inside your Norstar system. An internal line may still connect you with an external caller if you use it to access a line pool or to pick up a call

using Norstar call handling features such as Call Park or Call Pickup Directed.

**Internal number:** A number (also referred to as a Directory Number or DN) that identifies a Norstar telephone or device.

**Internal user:** Someone using a Norstar telephone within a Norstar system.

**ISDN:** See integrated services digital network.

**ISDN DN:** A directory number (DN) used by ISDN terminal equipment connected to the ICS. The system uses a maximum of seven ISDN DNs.

## K

**key service unit (KSU):** See ICS (integrated communication system).

## L

**Last Number Redial:**  

A feature that allows you to redial the last external number you dialed.



**Least cost routing:** See Routing service.

**Line:** The complete path of a voice or data connection between one telephone (or other device) and another.

**Lines:** A programming section that allows you to assign settings to each trunk and external line. Lines programming can be done by an installer or a system coordinator plus. A system coordinator can program the name of a line.

**Line restriction:** See Restriction filter.

**Line number:** A number that identifies an external line. The total number of lines depends on how many Trunk Cartridges are installed.



**Line Pool:**   

A group of lines used for making external calls. Line pools provide an efficient way of giving a telephone access to external lines without taking up many line buttons. A line is assigned to be part of a line pool under Trunk/Line data in Lines programming.





**Line Redirection:**   

A feature that allows you to redirect all calls on an incoming line to a destination outside the Norstar system. Once a line is redirected it cannot be answered within the Norstar system. The system may be set up to give a brief ring when a call comes in on a redirected line, under Capabilities in Terminals and Sets programming.

This feature differs from Call Forward in two ways. It redirects only external calls (not internal calls) and it redirects calls to destinations outside the system. Call forward redirects calls only to destinations inside the Norstar system. See Call Forward.

**Link:**   

If your Norstar system is connected to a Private Branch Exchange (PBX), you can use a Link signal to access special features. The Link signal can also be included as part of a longer stored sequence on an External Autodial button or in a Speed Dial code. The Link symbol () uses two of the 24 spaces in a dialing sequence.

**Long Tones:**    

A feature that allows you to control the length of a tone so that you can signal devices such as fax or answering machines which require tones longer than the standard 120 milliseconds.

**Loop Start Trunk Cartridge:** The Trunk Cartridge that allows you to connect loop start trunks to the Norstar system.

**Lunch schedule:** See Schedules, and Services.

## M

**M7000 telephone:** This telephone has a no display. It does have four memory buttons. (Note this telephone is only supported on systems running Profile 2, 3, or 4).





**M7100 telephone:** A telephone with a single line display and one programmable memory button without an indicator.

**M7208 telephone:** A telephone with a single-line display and eight programmable memory buttons with indicators.

**M7310 telephone:** A telephone that has a two-line display, three display buttons, 10 programmable memory buttons with indicators, and 12 dual memory programmable buttons without indicators. An M7310 can be equipped with a Busy Lamp Field.

**M7324 telephone:** A telephone with a two-line display, three display buttons, and 24 programmable memory buttons with indicators. An M7324 telephone can be equipped with one or two CAP modules.

**Maintenance:** A type of programming that is used to diagnose and repair problems in the Norstar system. Maintenance is accessed by an installer or a system coordinator plus.

**Malicious Caller ID (MCID)** This feature is a European ETSI-based network feature that allows a user to use     record the caller information at the service provider.

**Memory buttons:** Buttons that can be programmed to dial frequently used features or numbers automatically. See T7316, M7100, M7208, M7310, and M7324 telephone entries for their exact memory button configurations.

**Message:** A feature that allows you to send a message to another Norstar user. The Message feature also allows you to know if you have any messages waiting and maintains a Message Waiting List to keep a record of your internal messages and your (external) voice mail messages.

**Module:** A component of the Norstar 0X16 ICS.

**Module status:** A heading in Maintenance programming that shows what types of Trunk Cartridges are connected and whether they're busy, disabled, or malfunctioning.

### Move Line buttons:



A feature that allows you to move assigned lines to different buttons (with indicators) on your telephone.

**Music source:** A radio or other source of music can be connected to the ICS to provide music for the Music on Hold and Background Music features. A music source is not part of the Norstar system and must be supplied by the customer.

## N

**Names:** Names can be assigned to System Speed Dial numbers, external lines, telephones, and service schedules. This is done in programming. You can use up to 16 characters to name a System Speed Dial number, and seven characters to name a telephone, line, or schedule. If a Name has not been assigned, the line number or DN will appear on the display instead of a name.

**Network Call Diversion (NCD)**

Norstar Network Call Diversion (NCD) is a network function that allows forwarding and redirection of calls outside the Norstar network when using an ETSI ISDN line. Functionality is similar to that of External Call Forward (ECF).

**Network DN:** A number supplied by the ISDN network service provider for ISDN trunks (incoming lines).

**Night schedule:** See Schedules; Services.

**NT1 (Network termination type 1):** A device used to connect the U interface of an ISDN service provider and the S or T interface (the customer's equipment). The Compact ICS can act as an NT1 when equipped with a BRI-U2 or BRI-U4 Card.

**O**

**On hold:** A setting that controls whether external callers hear music, periodic tones, or silence when they are placed on hold. It is assigned under Feature settings in System programming.

**OPS:** Off premise station.

**OPX:** Off premise extension.

**Overlay:** See Programming overlay.

**Overflow:** A setting in Routing Service that allows users to decide what path an outgoing call will take if all the lines used in a particular route are in use when the call is made.

**Overrides:** One component of a restriction filter. Overrides are numbers you can dial even if they are forbidden by a more general restriction. See Restrictions.

**P**

**Page:**   

A feature you can use to make announcements over the Norstar system. You can make page announcements over the telephone speakers and/or external speakers.

**Page Timeout:** A setting that controls how long a Page Announcement can last. It can be assigned under Feature settings in System programming.



**Page zone:** An area in the office that receives internal page announcements independently of the rest of the office. Each page zone is identified by a number. Telephones are assigned to page zones under Capabilities in Terminals and Sets programming.

**Park prefix:** See Call park prefix.

**Park timeout:** The time before an unanswered parked call is routed back to the telephone that parked it. Park timeout is under Feature settings in System programming. See Call Park.

**Password:** A password is a specific sequence of digits that you enter to gain access to Norstar programming, to override restriction filters, or to use remote access with DISA.

**Passwords:** A programming section that allows you to assign or change COS passwords, Call log passwords, or any of the programming passwords. Once you access the Passwords section, you can only modify the passwords for your level of programming.

**Pause:**   

A feature that enters a 1.5-second delay in a dialing sequence on an external line. This is often required for signaling remote devices, such as answering machines, or when reaching through to PBX features or host systems. The

Pause symbol (⏸) uses one of the 24 spaces in a dialing sequence. For pulse dialing, [\*] inserts a 1.5-second pause into the dialing sequence.

**PBX:** private branch exchange.

**Pickup Group:** [ⓞ] [7] [5]

A telephone can be placed into one of nine call pickup groups. A call ringing at a telephone within a pickup group can be picked up at any other telephone within the same pickup group. A telephone is assigned to a pickup group under Capabilities in Terminals and Sets programming.

**Pool:** See Line pool.

**Pre-dial:** A feature that allows you to enter a number and check it on your telephone display before it is actually dialed. If the number is incorrect, you can edit it. The number is dialed only when you pick up the handset or select a line.

**Prime line:** The line on your telephone that is automatically selected when you lift the handset, press the Handsfree/Mute button or use an external dialing feature. A Prime line is assigned to a telephone under Line access in Terminals and Sets programming.

**Prime Set (prime telephone):** A telephone that provides backup answering for incoming calls on external lines. The prime telephone for a line will ring for any unanswered calls on that line. A prime telephone is assigned to a line under Trunk/Line data in Lines programming.

**Priority Call:** [ⓞ] [6] [9]

If you get a busy signal when you call someone in your office, you can interrupt them for an urgent call. This feature is enabled for a telephone under Capabilities in Terminals and Sets programming.

**Private line:** See Private to.

**Private network:** A telephone network consisting of owned or leased telephone lines used to connect different offices of an organization independently of the public network.

**Private to:** Allows you to select the telephone that will use the line exclusively. The line cannot appear on any other telephone, except the prime telephone for that line. Private lines cannot be placed into line pools. Private lines are assigned under Trunk/Line data in Lines programming.

**Privacy:** This feature determines whether a Norstar user may select a line in use at another telephone and join an established call. Privacy is enabled under Trunk/Line data in Lines programming, but can be turned on and off by users during individual calls.

**Programmed release:**

[ⓞ] [\*] [8] [9]

A feature that performs the function of the [ⓞ] button in a programmed dialing sequence.

**Programming:** Setting the way the Norstar system will work. Programming includes system-wide settings and individual telephone and line settings.

**Programming overlay:** A paper template that is placed over the memory buttons with indicators on the T7316, M7310 or M7324 telephone during programming. The overlay labels indicate the special function that each of the buttons takes on in programming.

**Public line:** An external line that can be assigned to any telephone and to many telephones. A line is assigned as Public under Trunk/Line data in Lines programming.

**Public network:** The regular telephone network that connects most homes and businesses.



**Pulse/tone dialing:** An external line setting for pulse or tone dialing. Pulse is the traditional method of dialing used by rotary-dial or push-button single-line telephones. Tone dialing allows telephones to communicate with other devices such as answering machines. Tone dialing is required to access the features that PBX systems may offer or to use another Norstar system remotely.

## R

**Recall:** See Link time.

**Receiver:** The handset of a telephone.

**handset card:** An abbreviated list of Norstar feature codes that is stored under the telephone handset. The card is found on a perforated sheet that comes with Norstar telephones.

**Remind delay:** A feature that causes a telephone to beep and display the message **On hold: LINENAM** when a call has been on hold for a programmable period of time. This period is the Remind delay.

**Remote access:** The ability to dial into a Norstar system from outside the system and make use of selected Norstar features. The lines, features, and dialing capabilities available to a remote user are determined by the Class of Service. If the remote access line is answered with DISA, the user must enter a Class of Service password to gain access to the Norstar system's features.

**Remote access dial restriction:** See Remote restriction.

**Remote capability:** A subset of Norstar features that are available to users connected through remote access.

**Remote restriction:** A restriction filter applied to a line in order to control which digits can be dialed during an

incoming remote access call. It is the equivalent of a set restriction for a remote user.

**Remote monitoring:** A feature that allows an off-site technician with a computer call in and troubleshoot your system through the built-in modem.

**Remote paging:** This feature allows remote users to use the Norstar paging feature. Access to this feature is governed by the Class of Service for the call. See Remote Access and Class of Service.

**remote user:** Someone who calls into a Norstar system from a telephone outside that system and uses Norstar features or lines. See Remote Access.

**Restriction filter:** Through a combination of restrictions and overrides, restriction filters prevent certain telephone numbers or feature codes from being dialed. Restriction filters can be applied to lines, sets, specific lines on a set, and to Class of Service passwords. The Norstar system can handle up to 100 restriction filters.

**Restriction service:** A Services section that allows you to assign alternate restriction filters to lines, telephones, lines on a particular telephone, and alternate remote filters to lines at specified times of the day and on specified days.

**restrictions:** One component of a Restriction filter. Restrictions are numbers you cannot dial when that filter is in effect. See also Overrides.

**Ring Again:**  

A feature that can be used when you cannot get through to someone on your Norstar system because their telephone is busy or there is no answer. Ring Again instructs the Norstar system to inform you when they hang up or next use their telephone.

**ring group:** A setting under Services that allows you to assign a number of different telephones to ring during one of the schedules. Up to 20 ring groups can be programmed by an installer or a system coordinator plus.

**ring type**

A feature that allows you to select one of four distinctive rings for your telephone.

**ring volume:**

A feature that allows you to set the volume at which your telephone rings.

**ringing service:** A Services section that allows you to make additional telephones ring at specified times of the day and on specified days.

**RIIs button:** Ends a call in the same way that hanging up the handset does. The Release button may also be used to end programming, Maintenance sessions, and feature operations.

**routing:** See Routing service.

**Routing service:** A programming section that allows outgoing calls to be directed automatically based on the numbers a caller dials. For Norstar systems linked in a network, routing can create a transparent or coordinated dialing plan. It can also be used to direct calls to the least expensive lines according to a Services schedule (sometimes called least cost routing).

**Run/Stop:**

A feature that creates a break point in a programmed external dialing sequence. When you press a programmed key, the system dials the number up to the run/stop. When you press it again, the system dials the digits following the run/stop.

## S

**S loop:** A type of loop provided by a BRI-ST Card. It connects the ICS to ISDN terminal equipment which uses an S interface.

**SAPS:** See station auxiliary power supply.

**Saved Number Redial:**

A feature that allows you to save the number of the external call you are on (providing you dialed the call) so that you can call it again later.

**Schedules:** Any of six different sets of services that can be applied to your Norstar system. A schedule can be activated manually from a control telephone or activated automatically at specified times. See also Services.

**Selective line redirection:** See Line Redirection.

**Service Modes:** See Services.

**Service Profile Identifier:** See SPID.

**Services:** A programming section that allows you to assign which telephones ring, which restrictions apply, and which call routing is used during any of six different schedules. There are three services: Ringing service, Restriction service and Routing service, all found in Services programming.

**Set:** A telephone.

**Set Copy:** A programming section that allows you to copy programmable settings from one telephone to another of the same type. Set Copy provides two options: duplicating System Data and User Data, or duplicating System Data only. Set Copy does not provide the

same copy capability as **COPY**, which is more selective of the settings that can be duplicated.

**Set filter:** See Restriction filter.

**Set lock (telephone lock):** This feature allows you to limit the number of features that may be used or programmed at a telephone. Full set lock allows very few changes or features, Partial set lock allows some changes and features, and No set lock allows any change to be made and any feature to be used. Set lock is assigned under Capabilities in Terminals and Sets programming.

**Set Relocation:** See Automatic Telephone Relocation.

**Shift button:** A small triangular button beside the dual memory buttons on the upper half of the M7310 telephone. You press the shift button to store or access features on the top half of the dual memory buttons.

**Show Time:**    

While on a call, accessing this feature allows you to see the current date and time on the Norstar telephone display.

**Software Keys:** A programming section used to enable the optional Remote monitoring feature. One setting provides a System ID, which an installer or system coordinator plus then uses to request three password keys from the Nortel Customer Response Center. Once these three passwords have been entered, the system will permit Remote monitoring.

**SPID (Service Profile Identifier):**

A number that identifies devices connected to an ISDN network. Devices may share a SPID, or a device may have more than one SPID depending on the number of channels it uses. SPIDs may be used to identify terminal equipment to the ICS, or to the service provider.

**Startup programming:** When a Norstar system is first installed and powered up, Startup programming must be performed before any programming can be done. Startup initializes the system programming to defaults.

**Station:** An individual telephone or other Norstar device.

**Station Auxiliary Power Supply**

**(SAPS):** A device which provides power to a Norstar telephone that is connected more than 300 m (975 ft.) and less than 1200 m (3900 ft.) from the ICS, or to a CAP module.

**Station set test:**    

A series of diagnostic tests for these components of a Norstar telephone: display, buttons, handset, speaker, and power.

**System Answer:** This feature simplifies answering calls by ensuring all calls are answered within a pre-set number of rings. Unanswered calls are monitored and answered by a pre-recorded greeting. Callers can dial an internal number or else the call is put on hold until it can be retrieved.

**System coordinator:** The person responsible for customizing the Norstar system through programming and for helping co-workers use the Norstar system.

**System coordinator password:** A one- to six-digit password that prevents unauthorized access to programming. The System coordinator password can be assigned and changed in Passwords programming.

**System coordinator plus:** A system coordinator who also performs technical and maintenance functions for the Norstar system.

**System coordinator plus**

**password:** A one- to six-digit password that prevents unauthorized

access to programming. The System coordinator plus password can be assigned and changed in Passwords programming.

### System coordinator plus

**programming:** A combination of common and installer programming settings. Press

\* \* C O N F I G ,  
then S C P L U S to access  
System coordinator plus programming.

### System coordinator

**programming:** The programming settings that are most commonly changed once the Norstar system is installed. Press

\* \* C O N F I G ,  
then A D M I N to access  
System coordinator programming.

**System Data:** An option in the Set Copy function. System Data refers to the programmable system settings that apply to all telephones and lines.

**System programming:** A programming section that allows you to assign and maintain certain settings on the Norstar system. System programming is performed by an installer or system coordinator plus.

**System speed dial code:** A three-digit code (001-255) that can be programmed to dial a telephone number up to 24 digits long. System speed dial codes are programmed for the entire Norstar system under the System Speed programming heading.

**System Startup:** See Startup programming.

**System Startup access code:** To begin System Startup, press

\* \* S T A R T U P .  
An Installer password is required before Startup programming can begin.

**System-wide Call Appearance (SWCA) keys** \* 5 2 0 to \* 5 3 5. These 16 feature codes can be assigned to buttons with indicators on a group of telephones to provide call appearance for incoming calls that can be answered by any telephone in the group. At the same time, the indicator displays the current status of the call.

## T

**T1:** Digital carrier system or line that carries data at 1.544 Mbps.

**T7000 telephone** This telephone has a no display. It does have four memory buttons. This telephone functions in the same way as the M7000 telephone. (Note this telephone is only supported on systems running Profile 2, 3, or 4).

**T7100 telephone** This telephone has a single-line display with one memory button. This telephone functions very similarly to the M7100 telephone.

**T7208 telephone:** A telephone with a single-line display and eight programmable memory buttons with indicators. This telephone functions very similarly to the M7208 telephone.

**T7316 telephone:** A telephone that has a two-line display, three display buttons, 16 programmable memory buttons with indicators, and eight line and memory programmable buttons without indicators. This telephone functions very similarly to the T7310 telephone.

**T7406 telephone:** This portable handset functions very similarly to the T7310 telephone. Functions and installation are all described in separate documentation specific to the telephone.

**T-loop:** A type of loop provided by a BRI-ST Card. It connects the ICS to an ISDN network using an NT1.

**Target lines:** Lines used to answer incoming calls only. A target line routes a call according to digits it receives from an incoming trunk. They are referred to by line numbers (049-074) in the same way as physical lines.

**TE:** See Terminal equipment.

**TEI (Terminal Endpoint Identifier):** A two-digit number used to identify devices that use an ISDN connection for D-channel packet service.

**Telco features:** A programming section that allows you to specify the external telephone numbers that are dialed by the Message feature to retrieve voice messages, or to set up CLASS (CMS) services for lines and sets. Telco features are accessed by an installer or a system coordinator plus.

**Terminal Endpoint Identifier:** See TEI.

**Terminal equipment (TE):** A generic term for devices that connect to an ISDN network. Examples of ISDN TE are ISDN telephones, computers equipped with ISDN cards and video terminals.

**Terminals and Sets:** A programming section that allows you to assign and change settings that apply to the telephones and other devices connected to the Norstar system. Terminals and Sets programming is performed by an installer or a system coordinator.

**Time and date:** A programming section that allows you to manually change time or date. The time and date can also be changed by pressing      and entering the Basic password or one of the programming passwords.

**Transfer:**

A feature that allows you to redirect a call to another telephone in your Norstar system, over a network or outside your Norstar system.

**Transfer Callback:** If a transferred call is not answered after a specific number of rings, the call will return to the telephone that made the transfer. The number of rings is assigned under Feature settings in System programming. Transfer Callback does not apply to calls transferred externally.

**Trunk:** The physical connection between the Norstar system and the outside world using either the public telephone system or a private network.

**Trunk Answer:**

A feature you can use to answer a call on any line that has an active Ringing service schedule, even if that line does not appear on your telephone. Trunk Answer is enabled under each schedule in Services programming.

## U

**U interface:** A two-wire ISDN interface used for both network connections and terminal connections to the ICS.

**U-LT:** A type of loop provided by a BRI-U2 or BRI-U4 Card. It connects the ICS to ISDN terminal equipment which uses a U interface.

**U-NT loop:** A type of loop provided by a BRI-U2 or BRI-U4 Card. It connects the ICS to an ISDN network.

**Unsupervised line:** A line for which disconnect supervision is disabled. If an external caller hangs up, the Norstar system does not detect the disconnection and does not hang up its line. See Disconnect Supervision.

**User Data:** User Data is an option in the Set Copy feature. User Data refers to the personal settings that are unique to an individual telephone, and are not programmed for the system. User Data is programmed at each telephone. These settings, for example, include User Speed Dial and the assignment of programmable memory buttons.

**User Filter:** See Restriction filter.

**User Preferences:** a programming section that allows you to assign autodialers, user speed dial codes, display contrast, and other settings to a specific telephone or person. You do not have to program these settings at the person's telephone. User preferences are assigned in Terminals and Sets programming.

**User Speed Dial:**  \* 4

Three-digit codes (256-279) can be programmed to dial external telephone numbers. User Speed Dial numbers are programmed for each telephone, and can be used only at the telephone on which they are programmed.

## V

**Voice Call:**  6 6

A feature you can use to make an announcement or begin a conversation through the speaker of another telephone in the Norstar system. The telephone you call will not ring. Instead, the person you call will hear a beep and then your voice. Their telephone will beep periodically to remind them that their microphone is open.

**Voice Call deny:**  8 8

A feature that prevents your telephone from receiving Voice Calls.

**Voice message center:** If you have subscribed to Call Display services you can receive visual Voice Message Waiting Indication, providing your

telephone has a display. If you have Voice Message Waiting Indication, you can program the telephone numbers required to access up to five different Voice Message Centers. You can also program which of the five Centers is to be accessed by each specific line.

## W

**Wait for dial tone:**  8 0 4

A feature that causes a sequence of numbers to pause until dial tone is present on the line before continuing to dial. The Wait for dial tone symbol () uses two of the 24 spaces in a dialing sequence.

# Index

## Symbols



\*\*DIALPAD (☎ \*\*3425723)

129

\*\*PROFILE

(☎ \*\*77634353) 129

\* \* C O N F I G

Installer programming

password 134, 292

\* \* S T A R T U P

Startup programming

password 130, 315

\* 7 Contrast Adjustment

260

\* 9 Run/Stop 183

\* 0 Button Inquiry 258,

263, 264, 271

\* 89 Programmed Release  
183

7 1 Link 183

78 Pause 174, 183

805 Station Set Test 259,  
260, 261

811 Call Display 153

83 Privacy 159

86 Background Music 271

6 2 Page 271

## Numerics

1stDisplay 153

2 ports busy 301

3 sets busy 301

## A

AbsorbLength 176

alarm

check current 304

codes 309

messages 208

remote reporting 229

System Administration Log  
306

telephone 208, 309

troubleshooting 311

Alarm 10 310, 311

Alarm 37 310, 311

Alarm 52-X-Y 310, 312

Alarm 61-X-Y 310, 312

Alarm 62-X-Y 310, 312

Alarm 63-Z 311, 312

Alarm 74 313

Alarm 75 313

Alarm74 311

Alarm75 311

alarms

hospitality 234

allocating log space 206

Allow last no 150

Allow link 150

Allow saved no 150

Analog Terminal Adapter (ATA)

accessing external lines 215

programming 144

Answer (setting) 223

answer calls

SWCA lines 209

Answer DN's 140

Answer line (setting) 223

answer mode 160

answer with DISA 160

ANY key

destination codes 175

Appearances 138

- appearances
  - setting SWCA controls 209
  - SWCA keys 209
- applying template 114
- assigning
  - Answer DNs 140
  - intercom buttons 140
  - line pools 138
  - lines 137
  - Prime line 139
- ATA
  - device 144
  - programming 144
- ATA (see Analog Terminal Adapter)
- ATA use 144
- attn attempts 234
- Attn duration 234
- auto associate, SWCA 209
- Auto Attendant, programming 219–220
- Auto DN
  - programming 217
- Auto privacy 159
- Auto-answer
  - loop start trunk and DISA 42
  - troubleshooting 265
- auto-attendant
  - fax switch 218
- Automatic Daylight Saving Time (see Daylight Saving Time)
- Automatic Route Selection (see Routing) 172
- Automatic Telephone Relocation 104
  - programming 208
- Automatic Time and Date 205
- auxiliary ringer
  - carrying capability 270

- installation 108
- programming 160, 270
- troubleshooting 270
- wiring 270

## B

- B1 and B2 directory numbers 85
- back 119
- Background Music 201
  - programming 109
  - troubleshooting 271
- basic
  - hospitality 233
- BKSP 120
- BRI
  - profile support 127, 128
- BRI (Basic Rate Interface)
  - card
    - configuration 26–30
- BRI (see also ISDN)
- Business Series Terminals
  - wall mounting sets 100
- Busy 297
- Busy Lamp Field 56, 295, 296, 334
- buttons
  - Feature 117
  - handsfree 117
  - Hold 117
  - programming button
    - definitions 119
  - programming telephones 117
  - Release 117
  - volume control 117

## C

- cables (see wiring)
- cadence
  - service tone 329
- Call Display



- and CCR groups 152
- programming 152
- using CLASS assignment 152
- call diversion
  - networks 235
- Call Log
  - log space 154
  - password 190
- call restriction
  - hospitality services 233
- Caller ID set 152
- Camp timeout delay 202
- CAP (see Central Answering Position)
- cartridge
  - checking the state 302
  - disabling 302
  - enabling 302
  - installation 72, 78, 81
- CCITT 113
- CCR 219
- central answering position (CAP)
  - line assignment 137
  - programming 212
- CHANGE 120
- Changing DN length 226
- CLASS assignment 152
- Class of Service
  - Auto DN 217
  - calls answered with DISA 217
  - dialing restriction 46
  - security 46
- Class of Service password 188
  - auto-answer system 45
  - line restriction 189
  - programming 189
  - remote access package 189
  - remote callers 43
  - user filter 189
  - with DISA 48
- clock
  - hospitality, setting time 233
- clocking cartridge 29
  - Installer
  - programming password 130
- cond pswd, programming 192
- configuration programming (see programming) 113
- connecting the wiring
  - to the distribution block 84
- connections
  - stand alone 30
- control telephone
  - programming 184
- coordinated dialing plan 49
- COPY 120, 123
- copy 136
  - line programming 156
  - system data 122
  - telephone programming 122
  - to a group of telephones 123
  - to a range of telephones 123
  - to a single telephone 123
  - Trunk and Line data 156
  - user data 122
- COS (see Class of Service)
- crest factor 329
- current, electrical 329, 330
- Custom call routing 219
- customizing
  - Call Display services 152
- D
- Daylight Saving Time, Automatic 205
- D-channel packet service (see ISDN)

- default
  - changing template 131
  - dialing restriction 147
  - directory number lengths 225
  - Installer password 190
  - line restriction 165
  - remote access packages 222
  - Restrictions 147
  - set restrictions 150
- delay
  - by number of rings 123
  - Camp timeout 202
  - Delayed Ring Transfer 203
  - Held Line Reminder 204
  - Park timeout 202
  - Transfer Callback 203
- Delayed Ring Transfer 203
  - to prime telephone 203
- desk information, hospitality 232
- desk pswd 192
- desktop conferencing using ISDN 53
- destination code 174
- destination codes
  - wild cards 175
- device
  - disabling 298
  - enabling 299
- diagnostic test results
  - System Test Log 304
- dial mode 158
- dial tone
  - absent on external lines 264
- dialing plan
  - coordinated 49
  - transparent 49
- dialing restriction 46
  - defaults 147
  - exceptions 148
  - for remote callers 166
  - line filter 189
  - line/set restriction 151
  - maximum length 148
  - maximum number 148
  - remote 47
  - remote user 166
  - removing a filter 149
  - Restriction service 47
  - restrictions 148
  - set restrictions 149
  - user filter 189
  - wild card character 147, 175
- dialpad
  - password 113
  - programming 126, 129
- Direct dial extension 210
- Direct Inward System Access 42
  - DN 217
  - remote callers 48
  - troubleshooting 283–285
- direct-dial digit
  - programming 216
- direct-dial telephones 211
- Directed Pickup 204
  - compared to Call Pickup 204
- directory numbers
  - B1 and B2 85
  - changing 132, 200
  - changing starting DN 131
  - defaults 85–87
  - entering 122
  - in a network 49
  - length 122, 132, 225
  - Port/DN status 294–299
  - transparent dialing plan 49

- DISA (see Direct Inward System Access)
- Disabled by sys. 297, 301
- Disabled by user 297, 301
- disabling
  - a device 298
  - a module 302
  - telephone during a maintenance session 294
- Disabling... 297, 301
- disconnect supervision 159
  - loop start trunks 45
- disconnect timer 245
- display buttons 120
- display unreadable
  - troubleshooting 260
- distribution block
  - connecting the wiring 84
- DN (see directory numbers)
- DN hunting (see multi-line hunt)
- DNs
  - fax 218
- DNs 122
- DTMF (see dual tone multifrequency)
- dual tone multifrequency 42
- E
- E&M
  - profile support 127, 128
- electrical requirements 57
  - power bar, use of 57
- electromagnetic compatibility 16
- electrostatic discharge 330
- emergency telephone
  - installing 98
  - troubleshooting 262
- enabling
  - a device 299
  - module or its cartridges 302
- Enabling... 297, 301
- environmental specifications 331
- equipment and supplies
  - installation checklist 55
- ETSI
  - MCID 235
  - network call diversion 235
- evening schedule 186
- event messages
  - checking time event occurred 305
  - maintenance 314
  - significant 314
  - system restarts 318
- EVT 196 315
- EVT 197 315
- EVT 210-YYYY 315
- EVT 211-YYYY 315
- EVT 220-3546 315
- EVT 221-3546 315
- EVT 222-3546 315
- EVT 268-07 315
- EVT 269-3546 315
- EVT 299 315
- EVT 373 315
- EVT 400 315
- EVT 407 315
- EVT 408 315
- EVT 416 315
- EVT 418 316
- EVT 419 316
- EVT 421 316
- EVT 422-3546 316
- EVT 423-3546 316
- EVT 425 316
- EVT 448 316
- EVT 449 316

- EVT 451 316
- EVT 452-3546 316
- EVT 453-3546 316
- EVT 454-3546 316
- EVT 822 316
- EVT799-XXXX YY 316, 317
- exception (see dialing restriction)
- exiting programming 121
- expansion cartridge
  - installation 81
  - upgrading for BRI 65
  - upgrading number of telephones 62
- expansion, system 62
- expired alarms, hospitality 234
- extension
  - Direct dial 210
- external code
  - programming 215
- external lines
  - access code 216
  - testing 255
  - troubleshooting 264
- external music source
  - connecting 108
  - programming 109
- external paging 109
  - troubleshooting 271
- extra-dial telephone
  - programming 170
- F
- fax DN 218
- feature button 117
- Feature Cartridge
  - installation 75
  - upgrading 63
- feature codes
  - troubleshooting 286
- features
  - and remote access 45
- file transfer using ISDN 53
- filters
  - hospitality room settings 233
- filters (see Restriction service) 146
- flash 207
- frequency 329
- full
  - autohold 161
  - hospitality 233
- G
- Group 4 fax using ISDN
  - applications 54
- H
- handsfree button 117
- heading 119
- hearing-aid compatibility 15
- Held Line Reminder
  - Remind delay 204
- Hold
  - button 117
  - setting SWCA controls 209
  - tones, music, or silence 201
- hospitality
  - call restrictions 233
  - password 192
  - room/desk information 232
  - service times 233
  - services programming 232
  - setting alarms 234
- Host delay 207
- hung lines 264
- Hunt groups 194
  - adding and removing members 195
  - assigning lines 196

- distributing hunt group calls
  - 197
  - member order 196
  - naming the group 200
  - overflow extension 199
  - programming hunt delay 198
  - routing calls if all members are busy 198
  - time in queue 199
  - usage metrics 323
- I
- icons on programming
  - telephones 117
- ICS
  - Background Music 201
  - cable connections 83
  - capacity 56
  - DN numbering 85–87
  - external loop start lines
    - wiring chart 90
  - mounting 71
  - numbering 84
  - telephone wiring chart 88
  - tools required for installation
    - 56
  - troubleshooting 278
  - Trunk Cartridge slots 244
  - wiring arrangement 90
- identify device connected to the system 295
- Idle 297
- idle line
  - search for 157
- If busy 163
- impedance
  - setting for line 162
- indicators
  - telephone buttons 119, 121
- initializing the system
  - Startup programming 112, 130
  - installation requirements
    - electrical requirements 57
    - equipment and supplies 55
    - internal wiring 58
    - location requirements 57
    - optional equipment checklist 56
    - spacing requirements 59
    - tools required 56
  - installation, planning 55
  - installation, system
    - cartridges 72
      - expansion cartridge 81
      - Feature Cartridge 75
      - Trunk Cartridge 78
    - general checklist 68
  - ICS 71
  - ISDN terminal equipment
    - 105–107
  - Norstar telephones 98–100
  - optional equipment 108
    - auxiliary ringer 108
    - external music source 108
    - external paging system 109
  - powering up the system 111
  - wiring 83–97
- Installer password 130, 134
- Integrated Services Digital Network (see ISDN)
- Integrated Voice Response (IVR) line 242
- Intercom keys
  - programming 140
- Internal Analog Terminal Adapter (I-ATA)
  - programming 144

- specifications 331
- internal numbers
  - B1 and B2 85
  - changing 132, 200
  - changing starting DN 131
  - entering 122
  - in a network 49
  - length 122, 132, 225
  - Port/DN status 294–299
  - transparent dialing plan 49
- internal remote administration
  - device (see remote administration)
- Internet access using ISDN
  - applications 54
- Intrl modem (internal modem setting) 228
- Invoke by hold, SWCA 209
- I-RAD (see remote administration)
- ISDN
  - capability packages 33
  - D-channel packet service 249
  - DN 250
  - LAN access using 54
  - Loop DN 251
  - loop termination 76
  - Network DNs 248
  - ordering service 33
  - profile 127, 128
  - profile support 127
  - S or T loop
    - additional power 106
    - wiring 105
  - SPID 246
  - TEI 249
  - terminal equipment, installation 105–107
  - wiring charts 92–96
- ISDN (Integrated Services Digital Network)
  - applications 53–54
  - bearer capability 23
  - BRI
    - card, configuration 26–30
  - capabilities 21
  - capability packages, ordering 31
  - clocking 30
  - data transmission speed 24
  - D-channel packet service 39
  - desktop conferencing using 53
  - equipment 53–54
  - file transfer using 53
  - Group 4 fax using 54
  - hardware configuration 26–29
  - installation programming 33
  - Internet access using 54
  - LAN to LAN bridging using 54
  - layers 23
  - leased line backup using 54
  - network synchronization 30
  - planning service order 23
  - programming sequence 33
- S
  - interface 28
  - loop, programming 36
  - reference point 28
- services and features 24
- SPID 36
- standards 31
- T reference point 29
- telecommuting using 54
- terminal equipment
  - configuration 27–28

- U interface 27
- U-LT
  - loop programming 36
  - reference point 27
- U-NT reference point 27
- videoconferencing and video telephony using 53
- ISDN network synchronization specifications 331
- K
- keys
  - software, IVR line 242
- L
- LAN
  - access using ISDN applications 54
  - router 54
  - to LAN bridging ISDN applications 54
- languages
  - profile 1 127
  - profile 2 127
  - profile 3 127
  - profile 4 128
- Last Number Redial 150
- leased line backup using ISDN applications 54
- least cost routing 181
- lightning protectors, verification 58
- line
  - hung 264
  - search for idle 158
  - troubleshooting 263–267
  - type 157
- line access 136
- line assignment 137
- line filter
  - programming 189
  - line numbers
    - entering 122
  - line pool 157
    - access 138
    - access code 214
    - in a dialing plan 49
    - troubleshooting 287
  - line restriction 46
    - defaults 165
    - programming 165
  - line selection
    - for a direct-dial telephone 211
  - line type 157
  - line/set restriction 46, 151
    - user filter 189
  - lines
    - BRI, about 42, 44
    - SWCA keys 209
- Link 150, 183
- Link time 207
- LIST 120
- location requirements
  - installation planning 57
- log
  - checking items 304
  - erasing the System Test Log 305
  - System Administration 306
  - System Test 304
- log space
  - allocation 206
  - number of spaces 154
  - programming 154
- logging calls
  - MCID 235
- long distance carrier access code, creating 180

- long distance carrier access
  - code, example 180
- loop current 331
- Loop DN 251
- loop length 330, 331
- loop resistance 330
- loop specifications 330
- loop start trunk 42
  - as prime line 43
  - auto-answer 42
  - configuration requirements 43
  - incoming calls 42
  - manual-answer 42
  - remote access from public network 45
- loops
  - profile support 127
- loss package 162
- loss/gain settings 162
- lunch schedule 186
- M**
- M7100 telephone
  - accessing external lines 215
- M7310, programming telephone 117
- M7324
  - programming telephone 117
- M7324 telephone
  - central answering position 212
- maintenance
  - alarm codes 309
  - beginning a session 292
  - current alarm 304
  - device version number 296
  - disabling module or its cartridges 302
  - enabling the module or its cartridges 302
  - event messages 314
  - identify device connected to system 295
  - module inventory 300
  - overview 291
  - Port/DN status 294–299
  - programming headings 291
  - records 325
  - state of a cartridge 302
  - state of a module 301
  - state of device 297
  - System Administration Log 306
  - System Test Log 304
  - system version 293
- Malicious call identification (MCID)
  - programming 235
- medium, hospitality 233
- MICS
  - basic password 116
- MICS-XC
  - basic password 116
- modem, internal 228
- module
  - check number of Trunk cartridges 300
  - checking the state 301
  - disabling 302
  - enabling 302
  - location 300
  - showing inventory 300
  - status 300
  - troubleshooting 273
  - verification 255
- Module status 291



- mounting Norstar telephones on wall 103
- moving telephones (see Automatic Telephone Relocation)
- multi-line hunt 24
  - groups 32
- music
  - license 17
  - source 17, 108
- N
- National ISDN standards 31
- network
  - options with Norstar 41
  - public network to Norstar system 41
  - security 46
  - transparent dialing plan 49
  - troubleshooting 280–289
  - user problems 280
- Network Call Diversion 26, 236, 343
- Network call diversion (NCD)
  - programming 235
- Network DNs (see ISDN)
- Network name display 227
- next 119
- night schedule 186
- No free lines 267
- Norstar
  - as off-premise extension 41
- Norstar system networking 41
- Norstar telephones
  - testing 255
- Not available 297
- notify set, hospitality 234
- NT1 (network termination type 1)
  - 30
  - stand alone connections 30
- numbers
  - entering 122
  - entering directory numbers 122
  - line numbers 122
- O
- occupancy, room 233
- off-premise extension
  - Norstar used as 41
- OLI 141
- on hold (see Hold)
- Open Switch Interval
  - disconnect timer 245
- optional equipment
  - installation checklist 56
  - testing 255
  - troubleshooting 270–272
- outgoing line identification 141
- overlay
  - button definitions 119
  - positioning on the set 118
- overlay, programming 117
- P
- Page Timeout 205, 206
- Page tone 204
- paging
  - installation 109
- Park prefix 215
- Park timeout delay 202
- parked call
  - retrieving 215
- password
  - admin 116
  - Basic 191
  - basic 116
  - calls answered with DISA 217
  - cond pswd 192
  - desk pswd 192

- dialpad 113
- Hospitality password 192
- Installer 130, 134
- installer 190
- I-RAD 191
- profile 113
- programming 190
- System Coordinator 134, 191
- System Coordinator Plus 134, 190
- user 116
- using DISA 48
- Phantom DN 209
- Port/DN Status 294–299
- ~~Port/DN status~~ 291
- ports
  - numbering 84
  - port numbering example 84
  - verifying 255
- positioning the overlays 118
- power bar, use of 57
- power specifications 329
- power, and S or T loop 106
- powering up the system 111
- PRI
  - profile support 127, 128
- Prime line 138, 158
- prime telephone 158
  - Delayed Ring Transfer 203
- private line 157
- profile
  - changing 129
  - password description 113
  - profile 1, North America 127
  - profile 2 127
  - profile 3 127
  - profile 4 128
  - programming 126
  - trunk cards, profile 1 127
  - trunk cards, profile 2 127
  - trunk cards, profile 3 127
  - trunk cards, profile 4 128
- profile 1, languages 127
- profile 2, languages 127
- profile 3, languages 127
- profile 4, languages 128
- programming
  - basic admin password 116
  - button definitions 119
  - call restrictions, hospitality 233
  - dialpad 113
  - dialpad, CCITT 129
  - hospitality cond password 192
  - hospitality desk password 192
  - hospitality password 192
  - hospitality services 232
  - indicators, telephone programming buttons 119
- ISDN 33
- on lines
  - ISDN (BRI) lines 35
- programming telephones 117
- special characters 121
- programming basics
  - access 113
  - copying telephone programming 122–125
    - copying system data 122
    - copying user data 122
    - group of telephones 123
    - range of telephones 123
    - single telephone 123
  - display buttons 120
  - entering 134

- entering numbers 122
- entering programming
  - using Installer password 134
  - using System Coordinator password 134
  - using System Coordinator Plus password 134
- exiting 121
- headings 133
- indicators, telephone buttons 121
- map
  - using Installer password 115
  - using System Coordinator password 116
  - using System Coordinator Plus password 115
- programming overview 113
- record 121
- ring delays 123
- suggested sequence 135
- tools 117
  - programming overlay 117, 134
- verifying programming 121
- programming buttons on a set
  - Answer DN 140
  - Intercom 140
- programming features on a set
  - 1st Display 153
  - ATA use 144
  - auxiliary ringer 108
  - Background Music 201
  - dialing restrictions 172
  - Last Number Redial 150
  - Link 150
  - OLI 141
  - On Hold 201
  - receiver volume 202
  - ringback 144
  - Saved Number Redial 150
  - Set lock 150
- programming lines
  - choosing a remote access package 221
- programming on lines
  - Ans mode 160
  - Ans with DISA 160
  - CAP line assignment 137
  - Dial mode 158
  - dialing restrictions 172
  - Discon timer 245
  - line access 136
  - line pool access 138
  - LossPkg 162
  - Prime line 139
  - Rec'd # 163
  - Trunk mode 159
- trunk/line data programming 155–158
  - VMsg center 167
- programming system features
  - Alarm reporting 229
  - alarm telephone 208
  - Auto Attendant 218, 219–220
  - Auto DN 217
  - Auto privacy 159
  - Aux. ringer 160
  - call log space 206
  - Caller ID set 152
  - Camp timeout 202
  - CAP assignment 212

- CLASS assignment 152
- Class of Service password 189
- control telephone 184
- Custom Call Routing 219
- Daylight time 205
- default digits 213
- Directd pickup 204
- Direct-dial 211
- DISA DN 217
- DN length 225
- DRT delay 203
- DRT to Prime 203
- external code 215
- Extl VMsg set 153
- extra-dial telephone 170
- Full AutoHold 161, 168
- Held reminder 204
- host delay 207
- Intrl modem 228
- line pool codes 214
- link time 207
- log space 154
- Page Timeout 205
- Page tone 204
- Park prefix 215
- Park timeout 202
- passwords 188
- prime set 158
- Rec'd # length 224
- remind delay 204
- remote access 220
- remote restrictions 166
- Restriction service 146–151, 164–166, 172
- Ringling groups 169
- Ringling service 168
- ringling sets (Ringling service) 171
- Routing 172–183
  - schedule times 186
  - Services 168, 185
  - Set Relocation 208
  - System Speed Dial 187
  - Telco features 151, 167
  - Time & Date 193
  - Trnsfr Callback 203
  - Trunk Answer 169, 170
  - VMsg center 167
- Provisioning 291
- Pswd (see Password)
- public line 157
- Q
- Q, dialpad 113, 129
- R
- RAD (see remote administration)
- radiated emissions 14
- reallocating log space 206
- Rec'd # 163
- Rec'd # length 224
- recall 207
- received number 163
- received number length 224
- receiver volume
  - programming 202
- recording information
  - System Administration Log 328
  - System Test Log 327
  - version number 325
- region 114
- registration
  - information for telephone company 16
- Release button
  - icons 117
- release button 121
- Release Reasons 232

- remote access
  - Class of Service password
    - 188
  - defaults for packages 222
  - dialing restriction 46
  - from public network 45
  - packages 221
  - programming 189, 221
  - restricting 220
  - security 46
- remote access packages (see remote access) 221
- remote administration
  - access to 223
  - alarm reporting 229
  - automatic answering 223
  - enabling 242
  - password 191
- Remote monitr 291
- remote restriction 47
  - user filter 189
- remote system access 45
- remote use
  - troubleshooting 280–289
- repair facilities 18
- replaced telephone status 262
- replacing a telephone
  - of different types 262
- requirements 57
  - installation 56
- reset memory 114
- restricting
  - line at telephone 151, 164
  - lines 165
  - remote access 220
  - remote callers 166
  - telephones 146, 149
- Restriction filter 164
- Restriction service 146, 164–166
  - line/set 149, 151
  - programming 172
  - schedules 149
- Restrictions
  - using 46–48
- restrictions
  - hospitality services 233
- Restrn filters 164
- retrieving
  - voice messages 240
- retry intrvl 234
- ring delay, programming 123
- ringback 144
- ringback detection 144
- ringer equivalence number 15
- Ringng service
  - night sched 169
  - programming 168
  - ring group assignment 169
  - ringng groups 169
- room # 232
- room occupancy 233
- room vacancy 233
- room/desk information,
  - hospitality 232
- Routing
  - Normal rtr 178
  - overflow 182
  - programming 172
  - setting up for local calling 177
  - setting up for long distance calling 178
  - using dialng restrictions 183
- S
- S
  - interface 28

- S or T reference point 28, 29
- S reference point 28
- Sampling, S-loop 250
- Saved Number Redial 150
- Sched 4 186
- Sched 5 186
- Sched 6 186
- schedule
  - names 185
- security 46
  - Class of Service 46
  - dialing restriction 46
- service profile identifier (see ISDN, SPID)
- service time
  - hospitality 233
- service tone cadences 329
- Services
  - evening 186
  - example of alternate call ringing 168
  - lunch 186
  - night 186
  - programming ringing sets 171
  - Sched 4 186
  - Sched 5 186
  - Sched 6 186
  - schedule names 185
  - schedule times 186
  - types 168
- Set lock 150
- set relocation (see Automatic Telephone Relocation)
- set restrictions
  - default 150
  - Last Number Redial 150
  - Link 150
  - programming 149
  - Saved Number Redial 150
  - Set lock 150
  - user filter 189
- shorting straps 77
- show 119
- show set 232
- Software Keys 242
- software keys
  - IVR line 242
- spacing requirements 59
- special characters on display 121
- specifications
  - environmental 331
  - internal analog terminal adapter 331
  - ISDN network
  - synchronization 331
  - power 329
  - service tone cadences 329
  - system immunity 330
  - telephone loop 330
- SPID (see ISDN)
- start and stop times
  - Services 186
- start DN
  - Startup 114
- Startup
  - programming 130
- startup
  - dialpad password 113
  - profile password 113
  - run Profile and Dialpad first 126
- state of device
  - checking 297
- SWCA
  - defining appearance keys 209

- setting controls 209
- switch
  - fax 218
- Sys admin log 291
- Sys test log 291
- SysID 242
- system admin, basic
  - programming 116
- System Administration Log 306
- System Coordinator password 134
- System Coordinator Plus
  - password 134
- system ID 242
- system immunity 330
- system prgrming
  - hospitality services 232
- system processor software 293
- system profile
  - choosing 126
- system profile startup 126
- System programming
  - ETSI programming 235
- system programming
  - setting SWCA controls 209
  - SWCA keys 209
- system restarts
  - event messages 318
- system settings
  - Answer key 208
  - Automatic Time and Date 205
  - Direct dial extension 210
- System Test Log 304
  - capacity 304
  - event messages 314, 318
  - recording 327
- System version 291
- system version
  - check version number 293
  - system processor software 293
- system-wide call appearances, see SWCA
- T
- T reference point 29
- T1
  - profile support 127, 128
- T7316
  - programming telephone 117
- target lines
  - about 42, 44
  - and received number 163
- TC on KSU 243
- TE (see ISDN terminal equipment)
- TEI (see ISDN)
- telecommuting using ISDN
  - applications 54
- telephone
  - alarm set 208, 309
  - CAP 212
  - control sets 184
  - dead 261
  - Feature button 117
  - handsfree button 117
  - Hold button 117
  - installation 100, 102
  - mounting on the wall 103
  - moving 208
  - moving (Automatic Telephone Relocation) 104
  - Release button 117
  - replacing 261, 262
  - testing 261
  - troubleshooting 260–262
  - voice message waiting indication 153

- volume control 117
- telephone loop specifications 330
- telephones
  - button icons 117
  - programming 117
- temperature
  - operating 331
  - storage 331
- template
  - changing default 131
  - Startup 114
  - types 131
- Terminal Endpoint Identifiers (see ISDN, TEI)
- terminating resistors (see termination for ISDN loop)
- termination for ISDN loop
  - description 76
  - shorting straps 77
- termination resistance setting 162
- testing
  - checklist 255
  - emergency telephone 255
  - external lines 255
  - Loopback tests 320
  - modules 255
  - Norstar telephones 255
  - optional equipment 255
  - ports 255
  - system 255
  - System Test Log 327
  - wiring connections 255
- Tests 291
- time display, hospitality 233
- time format, hospitality 234
- timer
  - disconnect 245
  - times, service 233
- tone
  - fax tone detection 218
- tones
  - hospitality 234
- tools 56
  - programming 117
- Transfer Callback 203
- transfer to remote administration 254
- transparent dialing plan 49
- troubleshooting 257
  - alarms 311
  - auxiliary ringer 270
  - Background Music 271
  - checklist 258
  - emergency telephone 262
  - external paging 271
  - feature codes 286
  - general procedure 259
  - ICS 278
  - line pools 287
  - lines 263–267
  - modules 273
  - network or remote users 280–289
  - optional equipment 270–272
  - replacing a telephone 261
  - telephones 260–262
  - Trunk Cartridge 273
  - types of problems 258
- Trunk Answer
  - programming 169, 170
- trunk cards
  - profile 1 127
  - profile 2 127
  - profile 3 127
  - profile 4 128
- Trunk Cartridge



- checking the state 302
- configuration 243
- installation 78
- troubleshooting 273
- Trunk cartridge
  - number attached to a module 300
- Trunk data
  - settings 155, 243
- Trunk mode 159
- trunk/line data
  - copy 156
- trunks
  - loop start 42
  - type 156
- U
- U interface 27
- U-LT reference point 27
- unconfigured 297, 301
- unsupervised trunk mode 159
- U-NT reference point 27
- UPDATE 121
- Updating state 301
- upgrading your system 242
- Usage metrics
  - Hunt groups 323
- User preferences
  - capabilities 145
- V
- vacancy, room 233
- version number
  - check device 296
  - recording 325
- videoconferencing and video
  - using ISDN applications 53
- VIEW 120
- VIEW-> 120
- VMsg centr tel#s (see Voice Message center telephone numbers)
- Voice Message center
  - telephone numbers 240
- voice message waiting indication 153
- voltage 329, 330, 331
- W
- wall mounting
  - BST sets 100
- wall mounting Norstar
  - telephones 103
- wild card character 147, 175
- wild cards
  - destination code 175
- wiring 57
  - auxiliary ringer 270
  - BRI-ST 93
  - BRI-U 94
  - distribution block 84
  - grounding 57
  - I-ATA 90
  - ICS 83–97
  - ICS external loop start lines 90
  - Loopback test 320
  - page 90
  - port numbering 84
  - S or T terminal equipment 105
  - U-LT terminal equipment 106
  - U-NT network 96
  - verifying 255
- Z
- Z, dialpad 113, 129



## Backup programming overlays

